

Tessino
03-20



ORIGAMI
PASQUALE D'AURIA

origamidauria.it



origamidauria

1

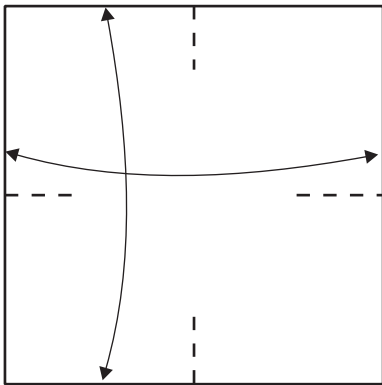

2

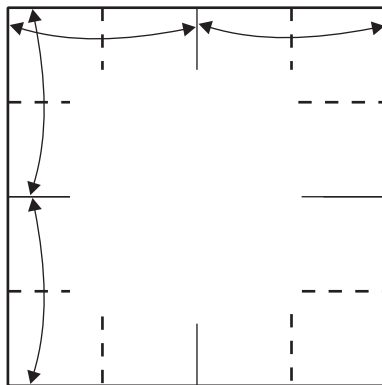

3

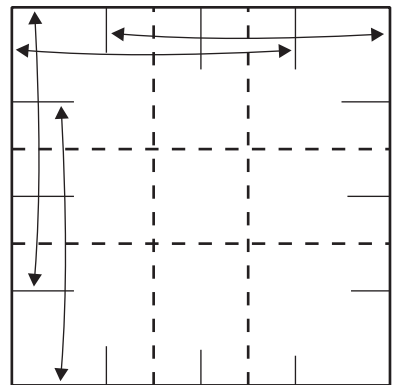

4

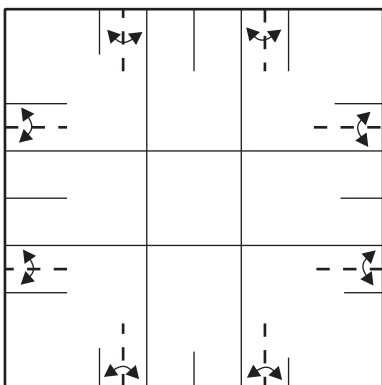

5

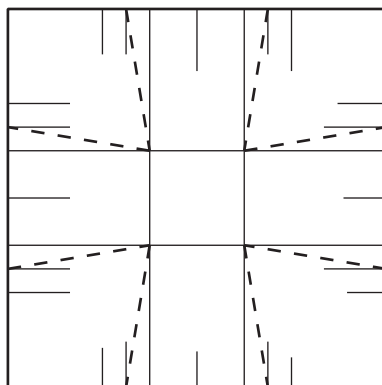

6

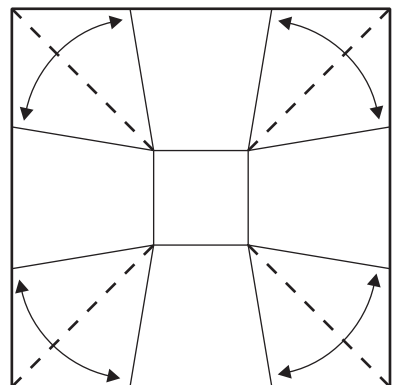

1



7

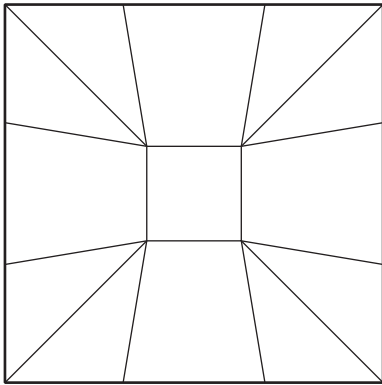

8

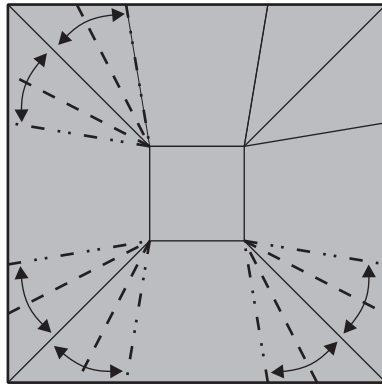

9

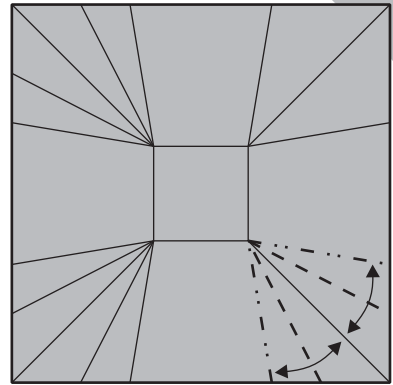

origamidauria.it

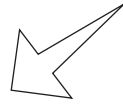

10

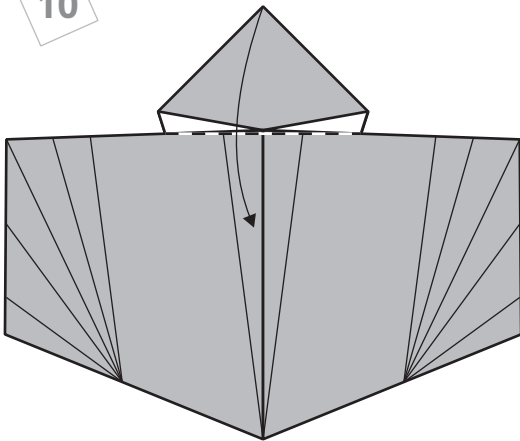

11

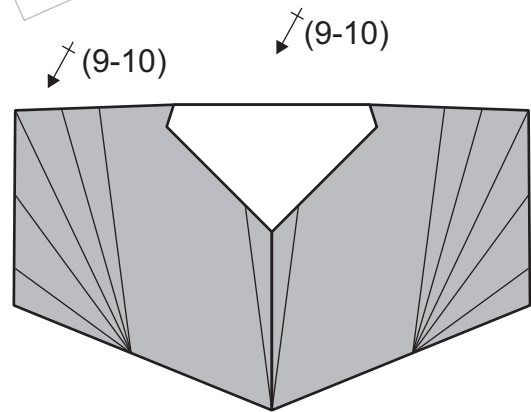

12

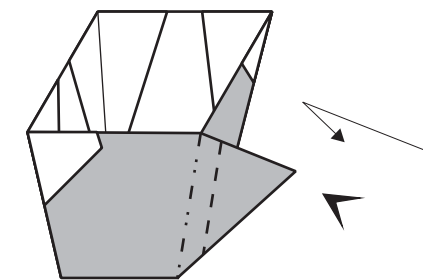

13

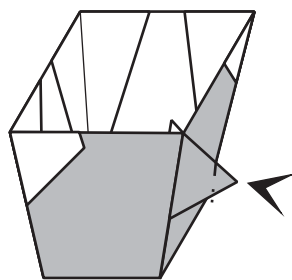

14

con una piega a valle portare in giù la punta interna e bloccare il manico

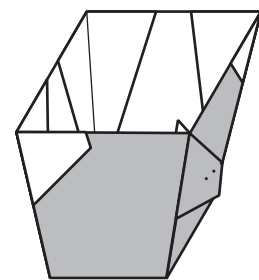



15

con una piega a valle bloccare l'angolo

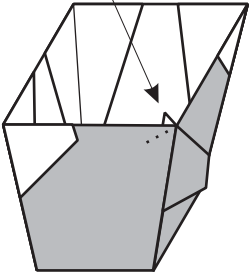

16

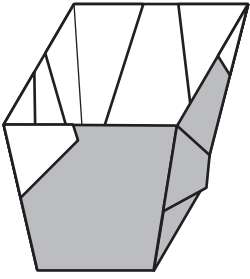

vuoi un caffè?

no, non potrei dormire

ma sono le otto

appunto sto andando in ufficio

