

Sudoku di P. D'Auria

<http://www.origamidauria.it>

Contenitore

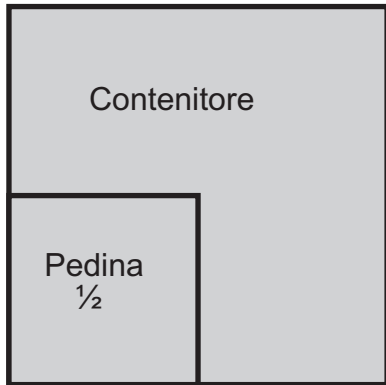

1 dividere in settimi

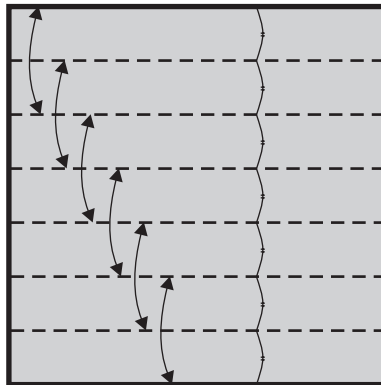

2 dividere in settimi

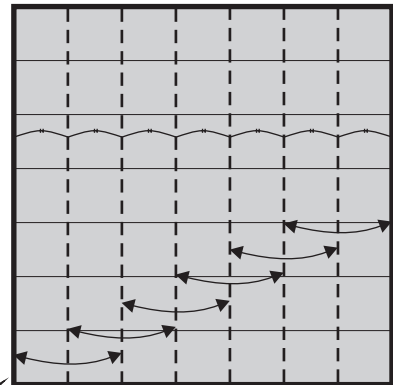

3

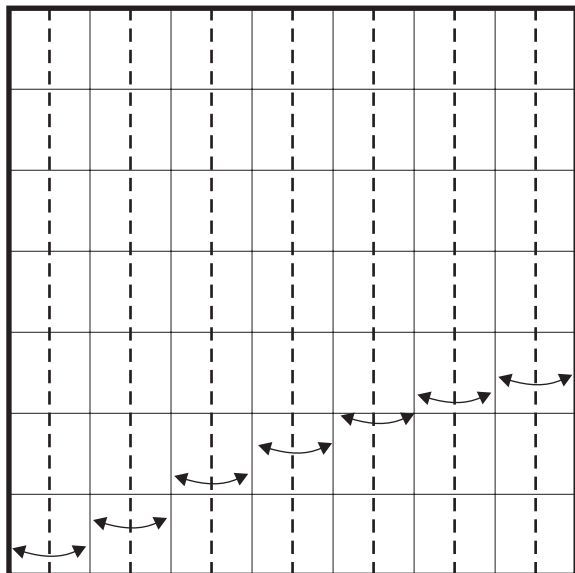

4

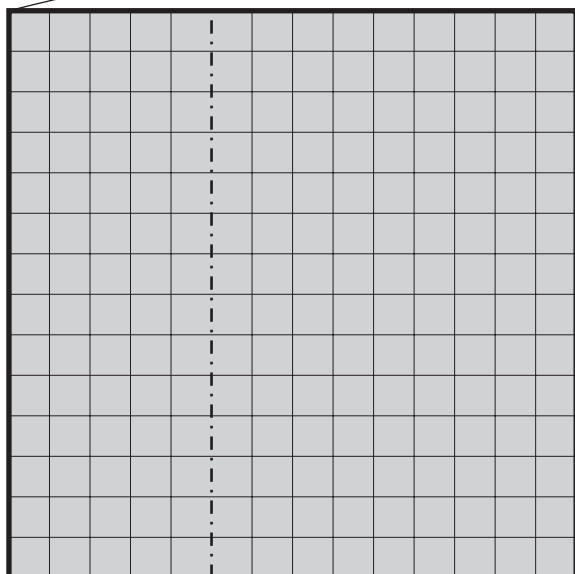
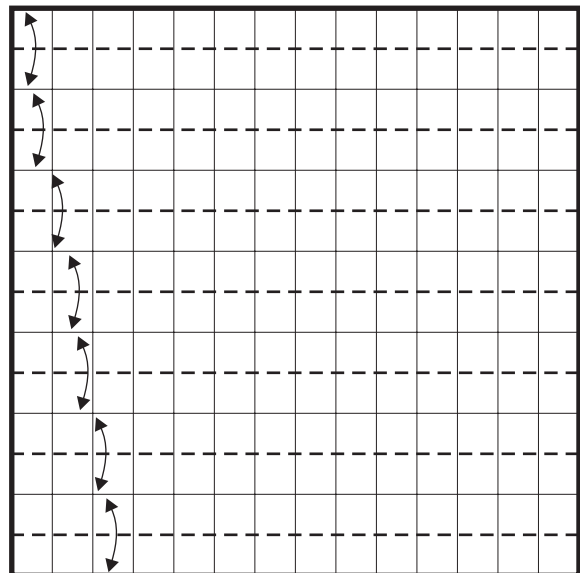

5

6

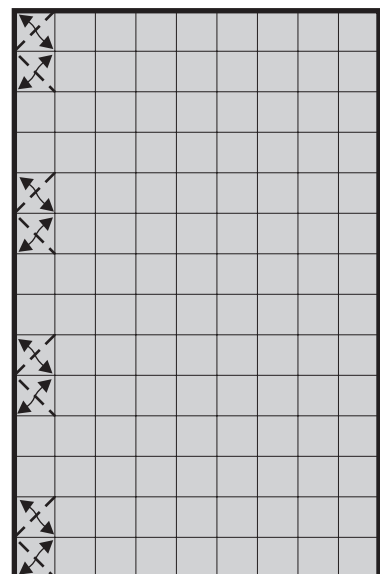

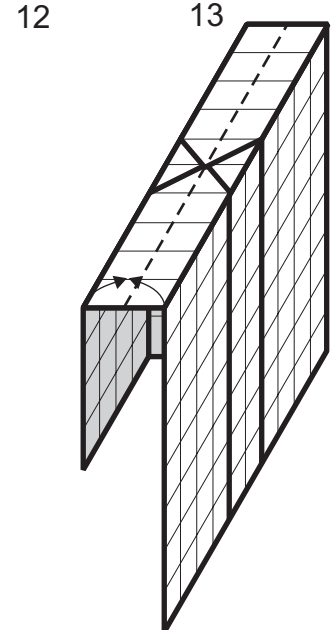
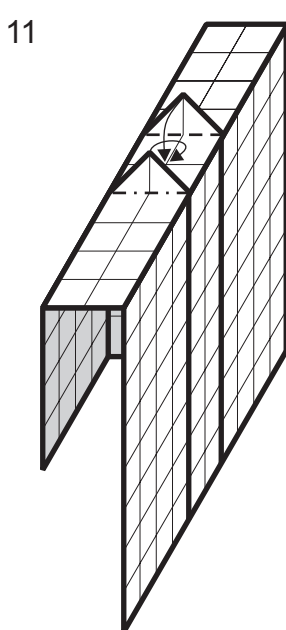
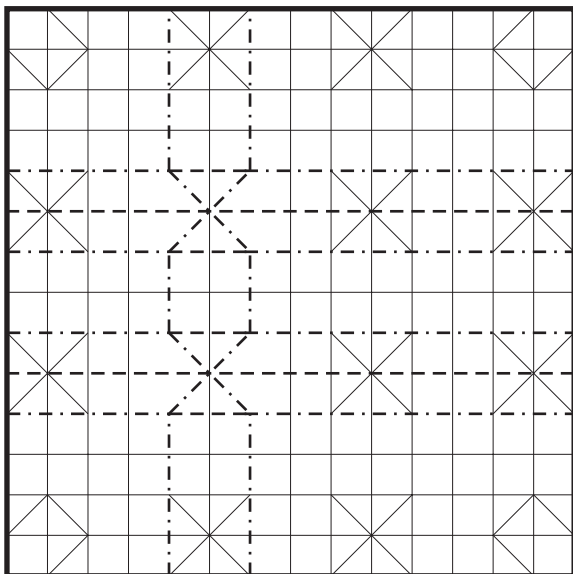
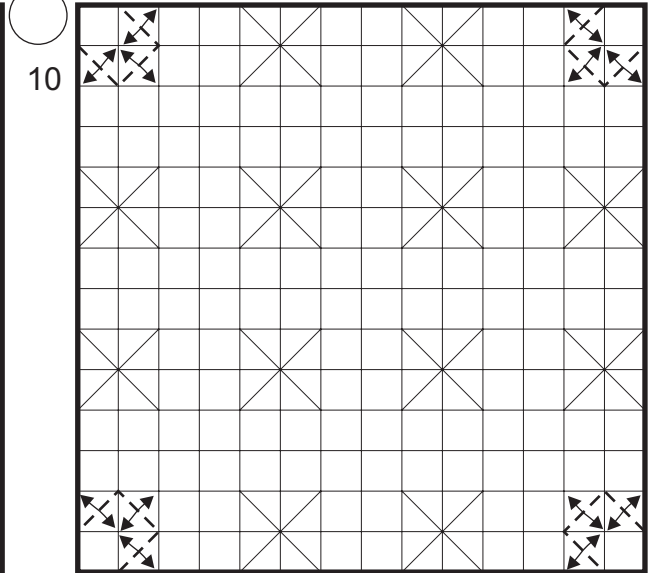
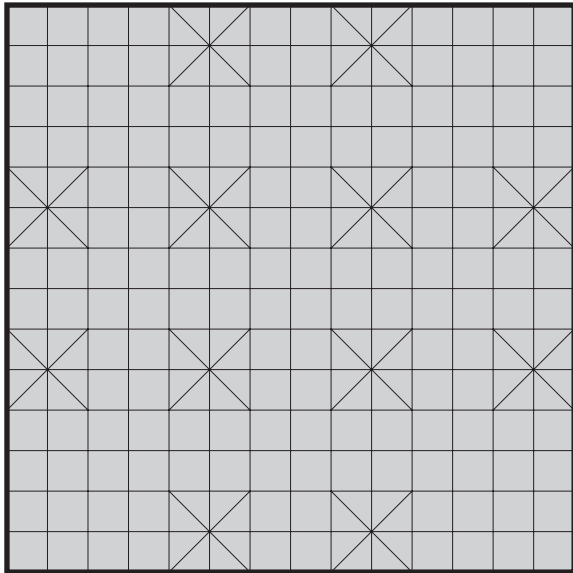
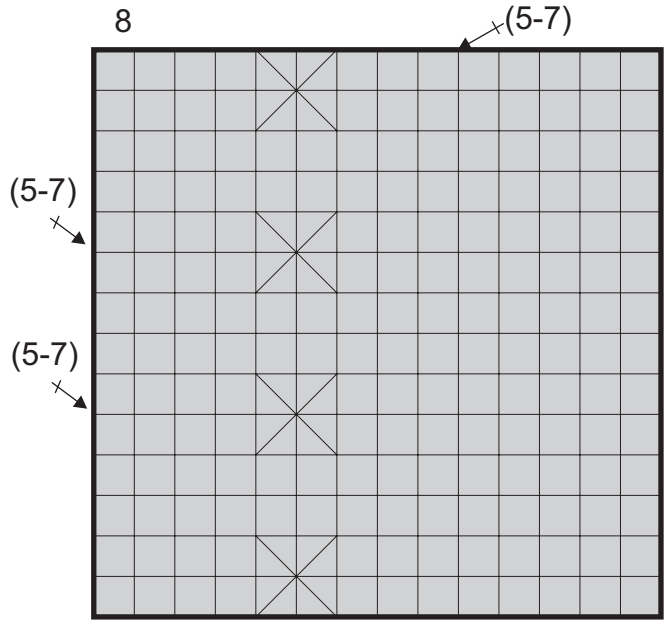
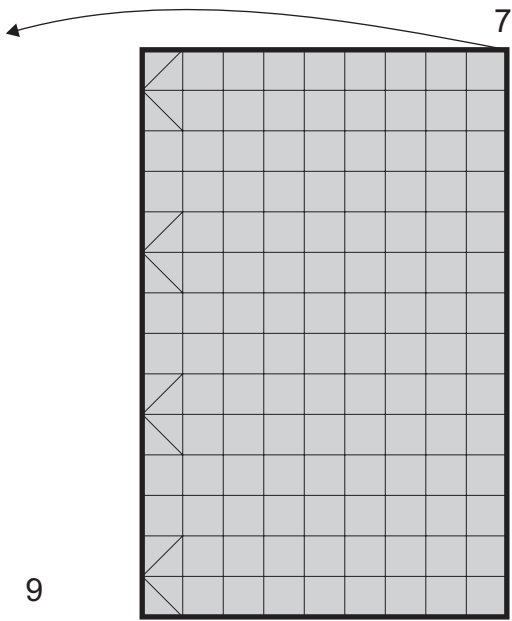

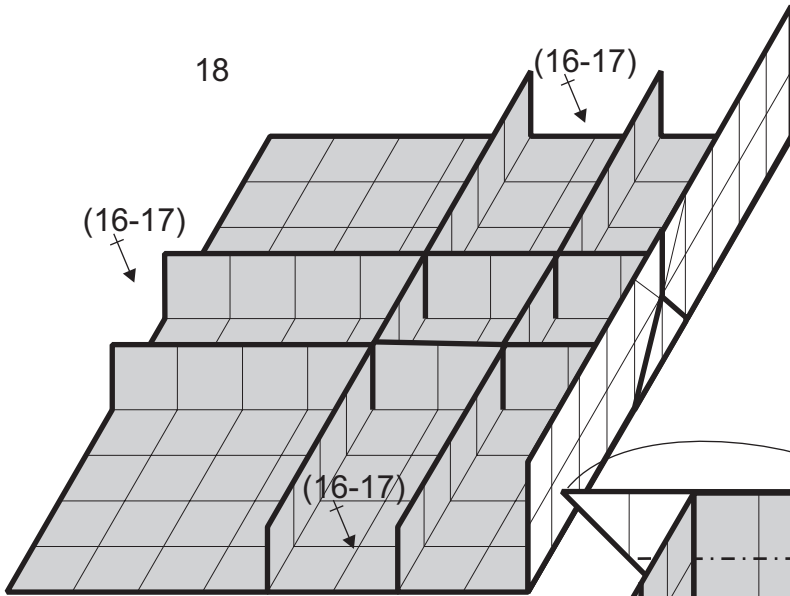
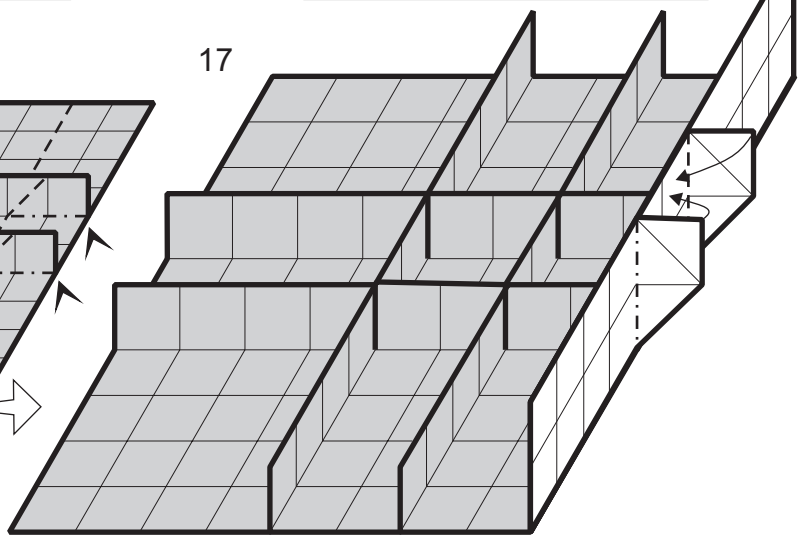
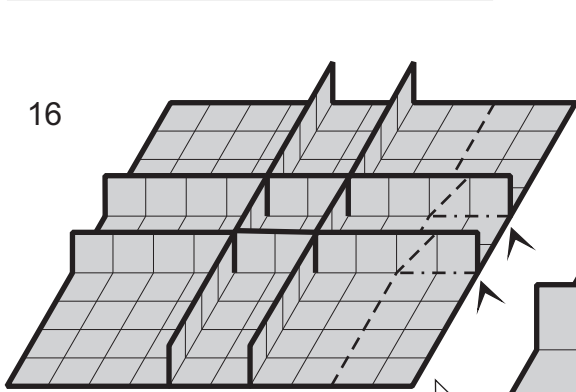
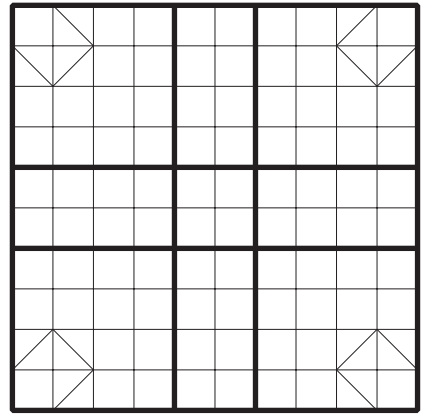
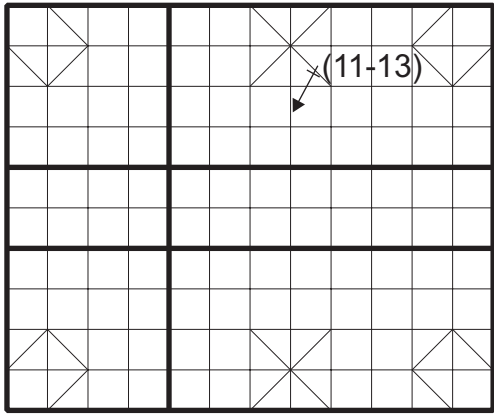

(16-17)

(16-17)

(16-17)

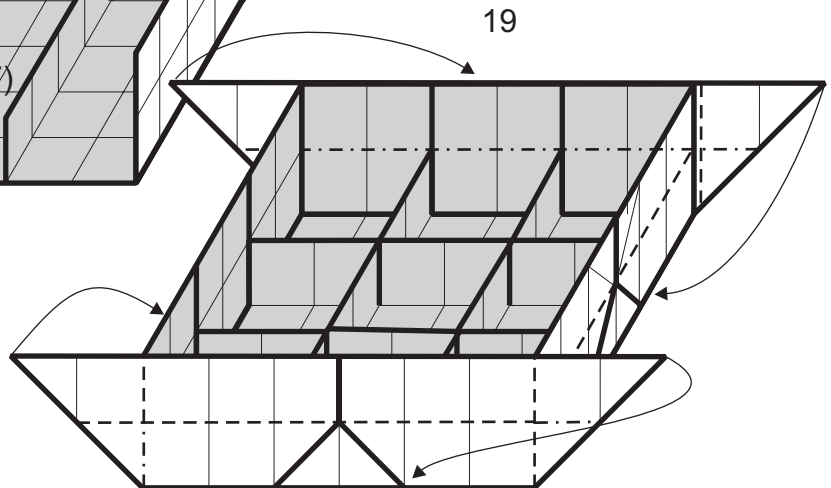

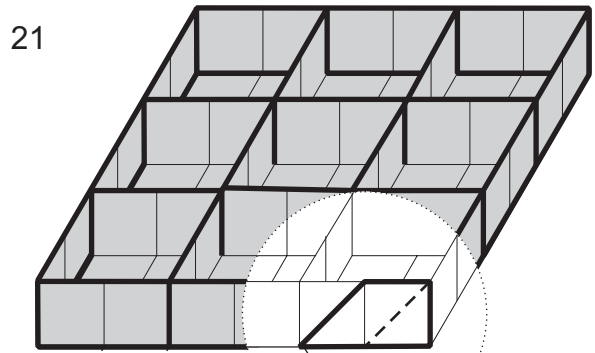
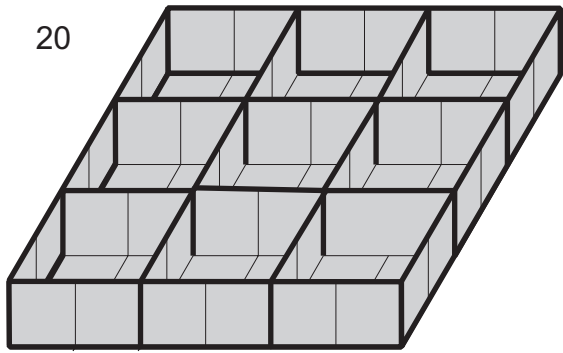

22 bloccare intascando

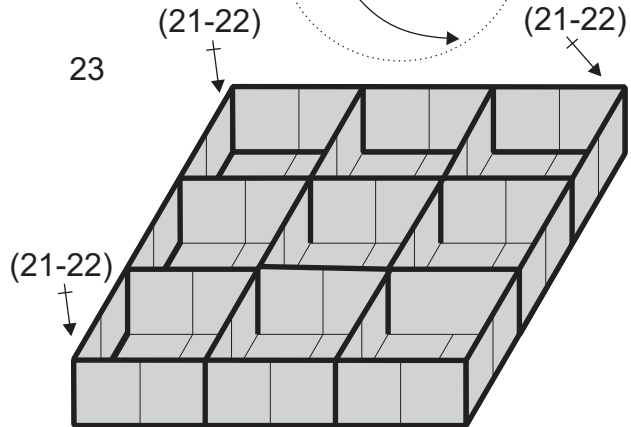
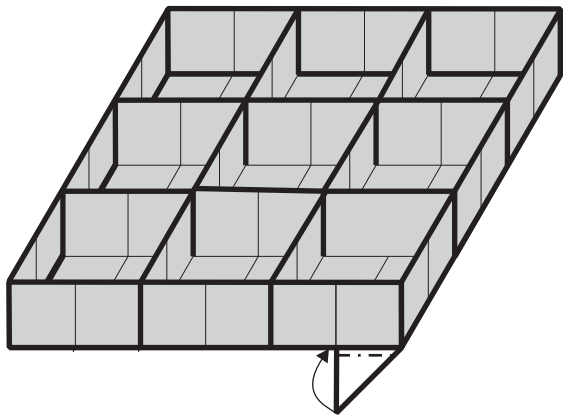

24 bloccare intascando

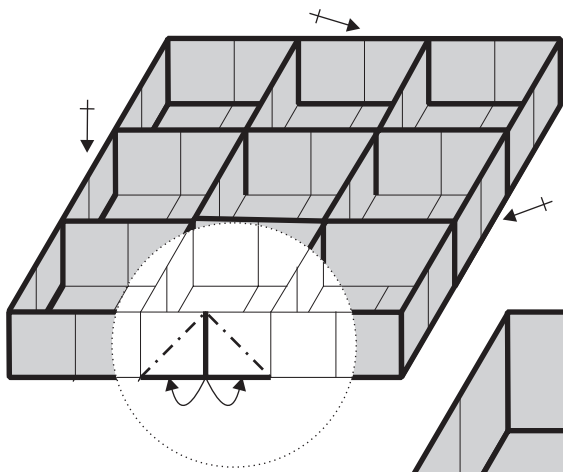

25

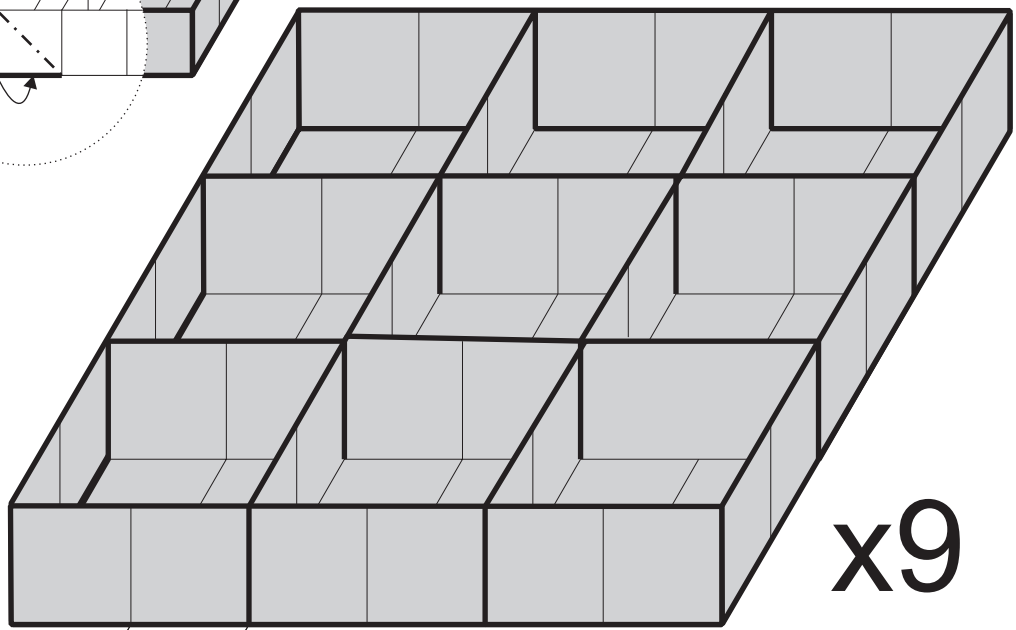

x9

Pedina

26

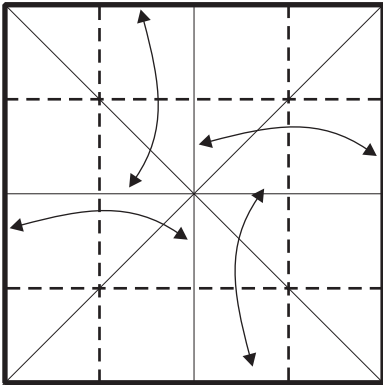

27

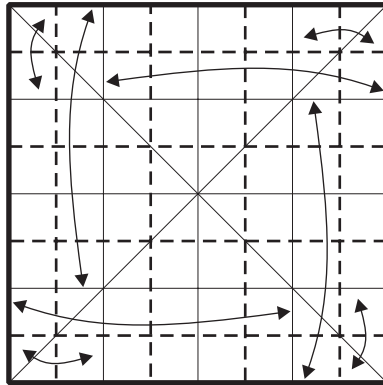

28

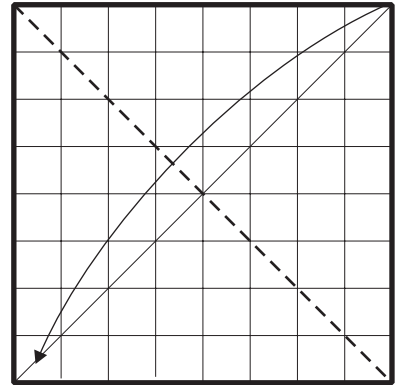

29 fare due pieghe rovesciate a fisarmonica

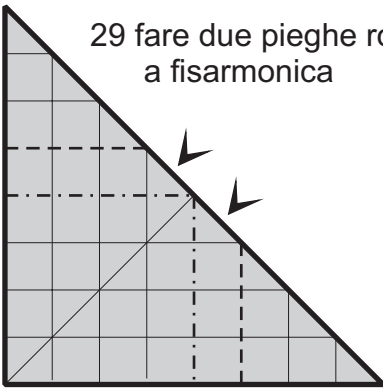

30

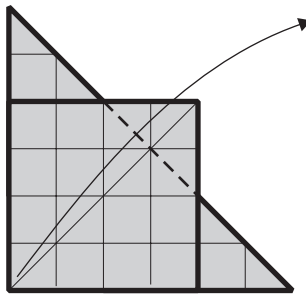

30

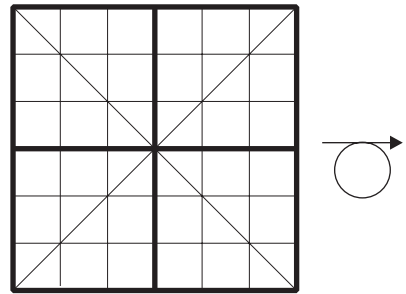

31

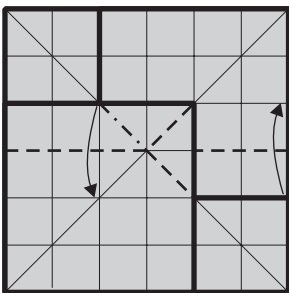

32

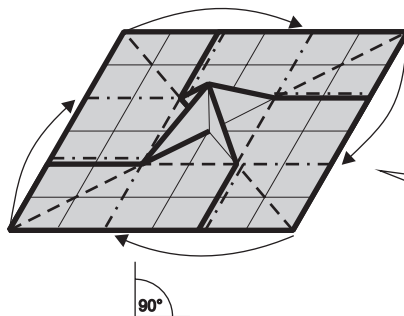

33

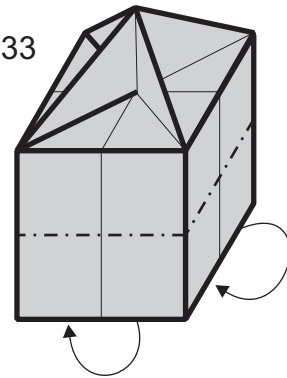

34

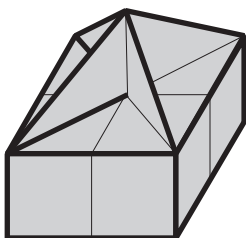









- I° colore X9
- II° colore X9
- III° colore X9
- IV° colore X9
- V° colore X9
- VI° colore X9
- VII° colore X9
- VIII° colore X9
- IX° colore X9

usate 9 colori totalmente diversi tra loro, perché quando giochiamo dobbiamo concentrarci solo sulle varie combinazioni numeriche senza nessuna esitazione sul riconoscimento dei colori.

esempio

2		1				6		
7		4				1		8
3			5	7	1			
5		9				7		2
			6	2	9			
1		6				3		9
			9	4	8			1
9		3				4		7
		5				2		6

- 1= 
- 2= 
- 3= 
- 4= 
- 5= 
- 6= 
- 7= 
- 8= 
- 9= 

35

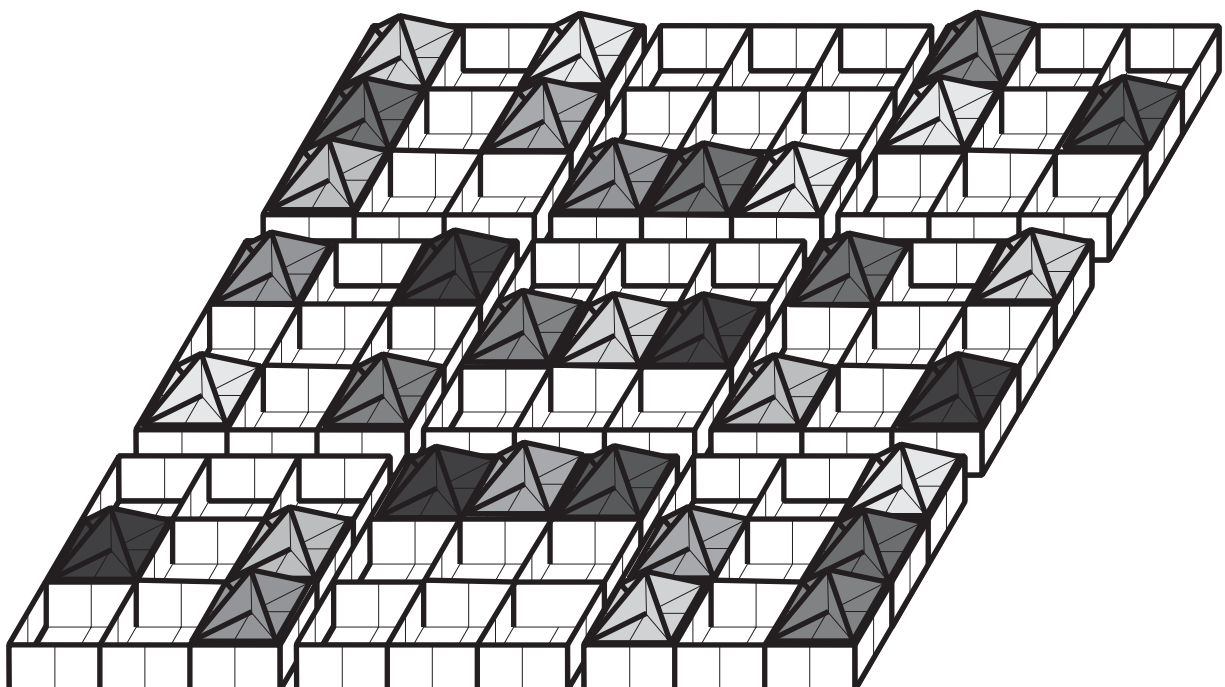

Il sudoku è terminato, ma per completarlo faremo anche la scatola per trasportarlo.
scatola sudoku

Usiamo due quadrati con il lato 3,3 volte più grande del quadrato usato per i contenitori piccoli.

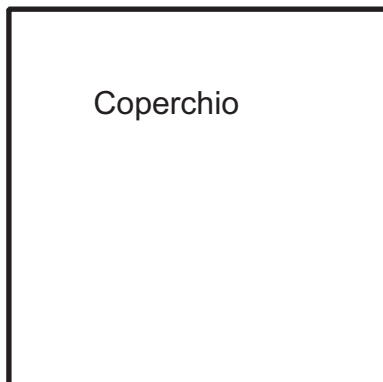

Contenitore

36

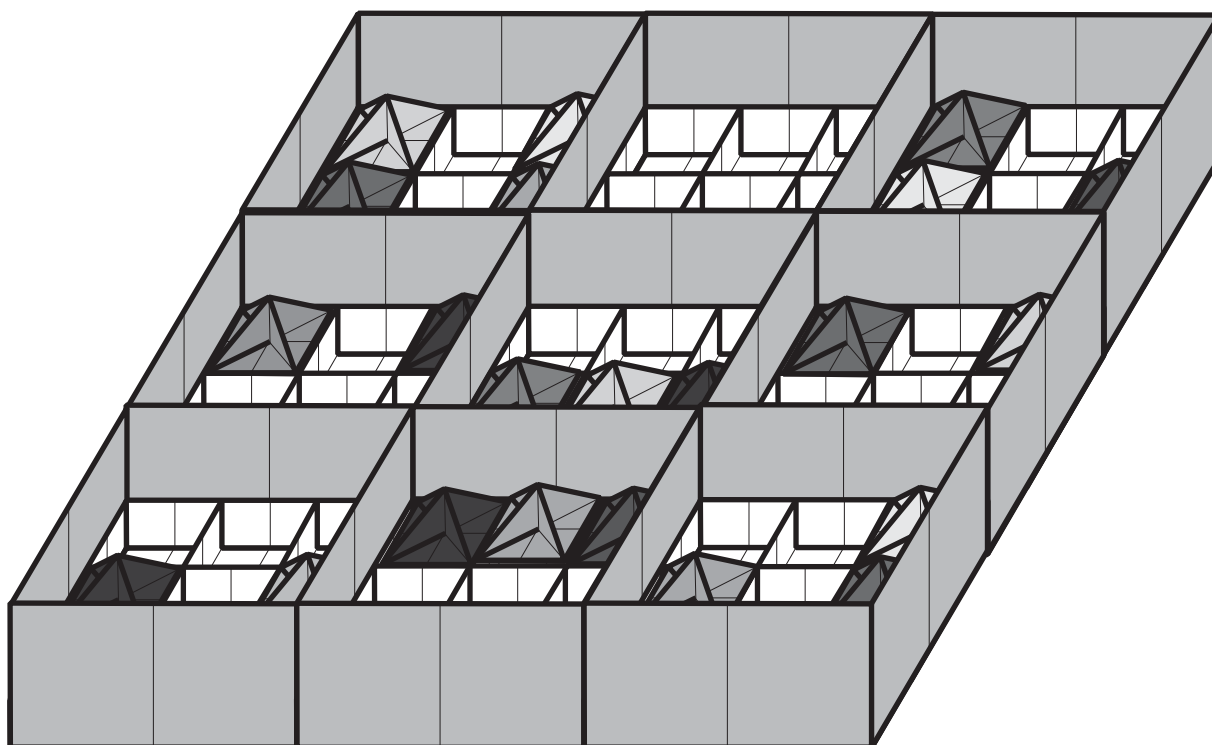

37

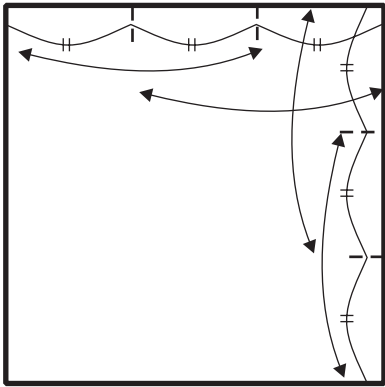

38 Coperchio

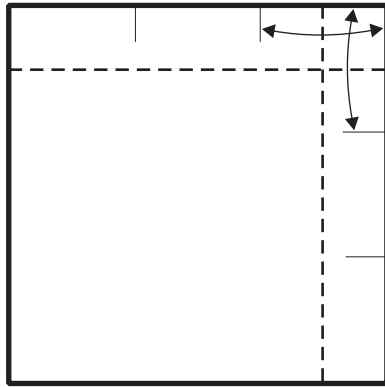

39

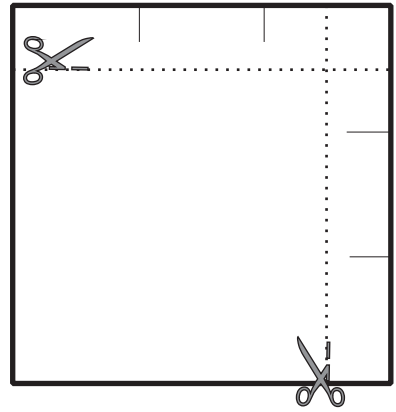

40

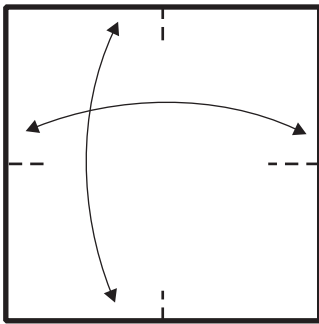

41

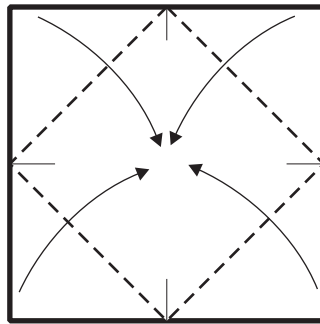

42

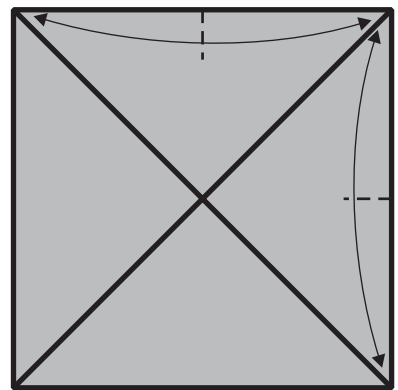

43

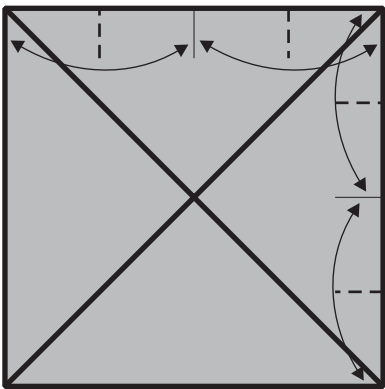

44

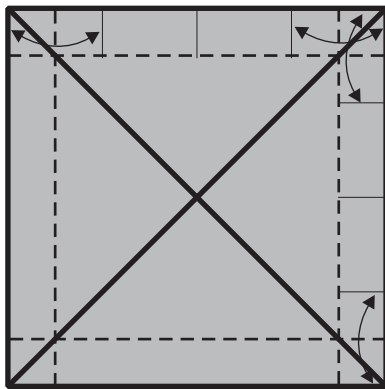

45 riaprire

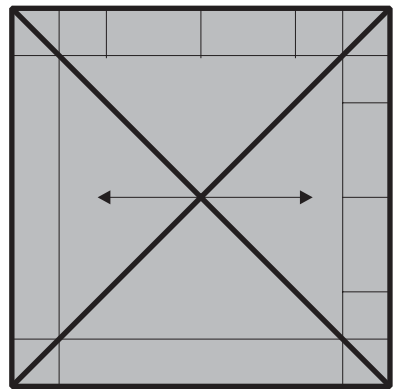

46

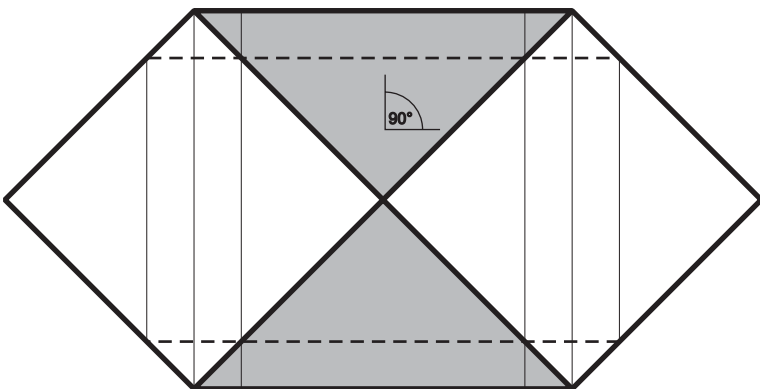

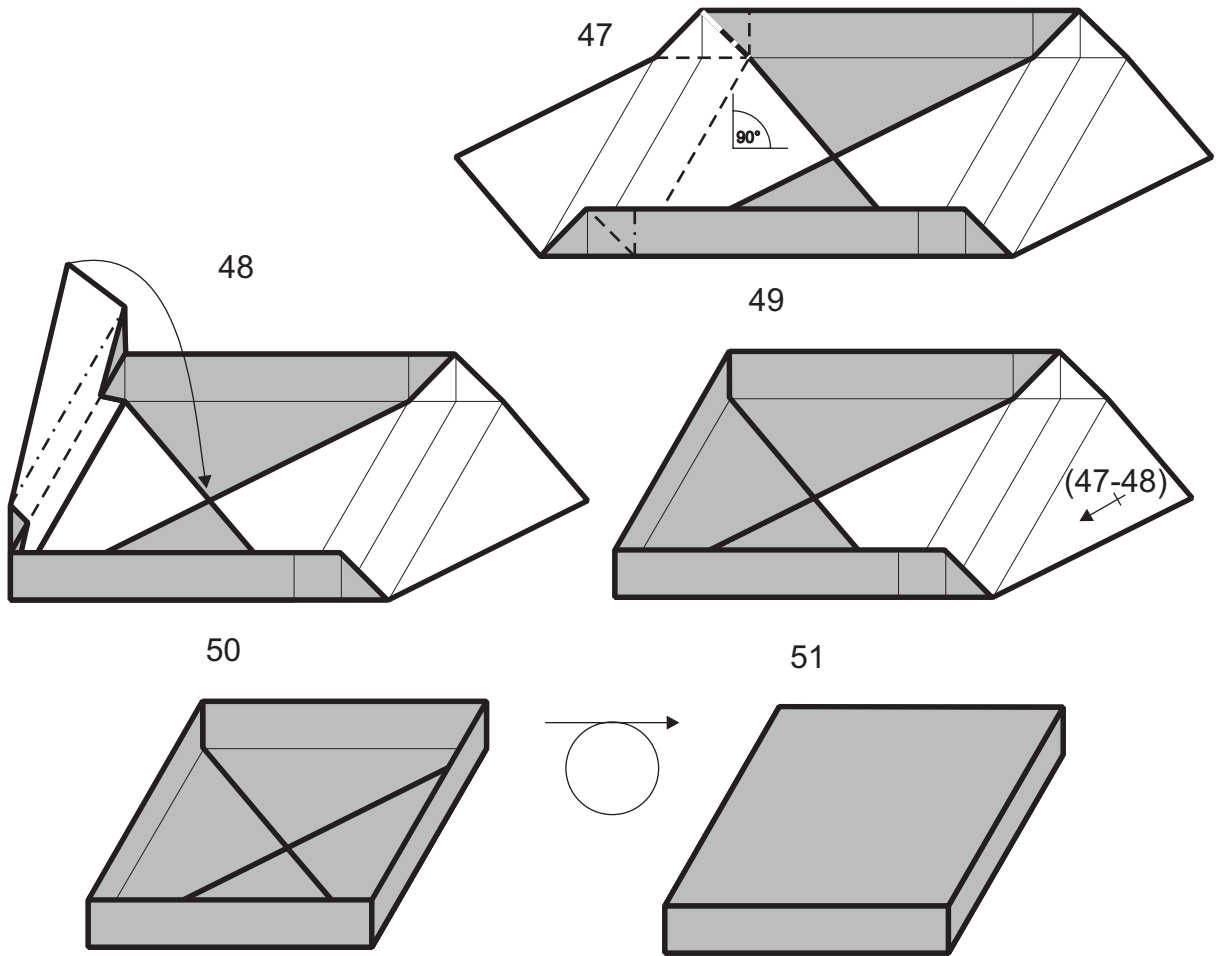

...doveva venire un genio del sudoku, uno che trova tutte le combinazioni in pochi secondi!

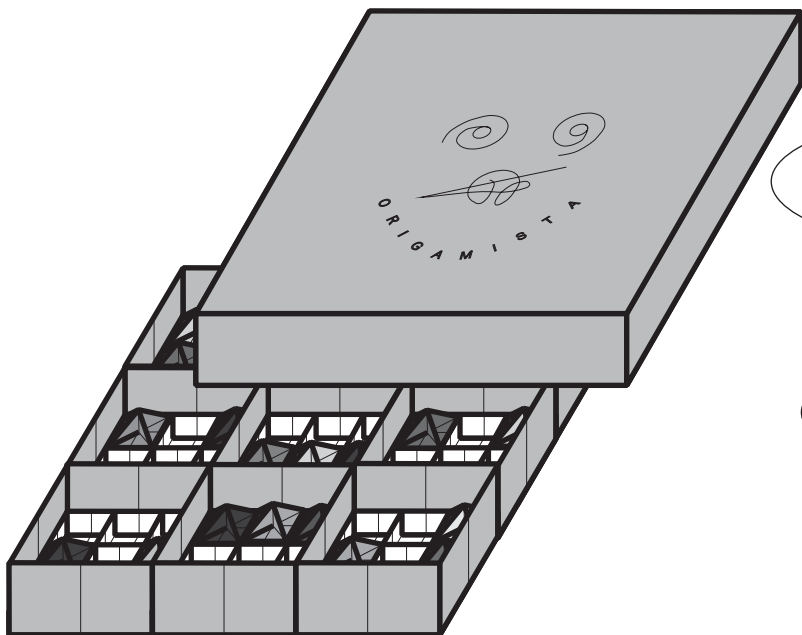

e come mai non è venuto?

...non ha trovato la strada!!!