

Orchidea selvatica (ophrys sphegodes) di P. D'Auria

<http://digilander.libero.it/origamidauria>

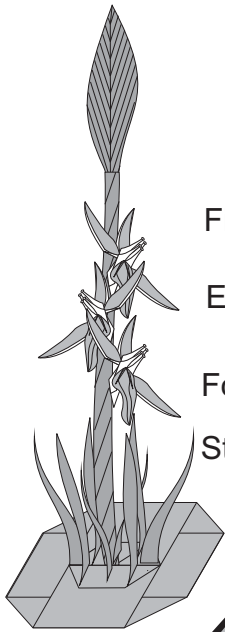

Fiore $L \times L$ misura consigliata 7,5 cm, un lato verde e uno colore petalo.

Erba $4L \times 4L$ misura consigliata 30 cm, tutto verde.

Foglia $L \times L$ misura consigliata 7,5 cm, tutto verde.

Stelo $L \times 4L$ misura consigliata 7,5x30 cm, tutto verde.

Fiore

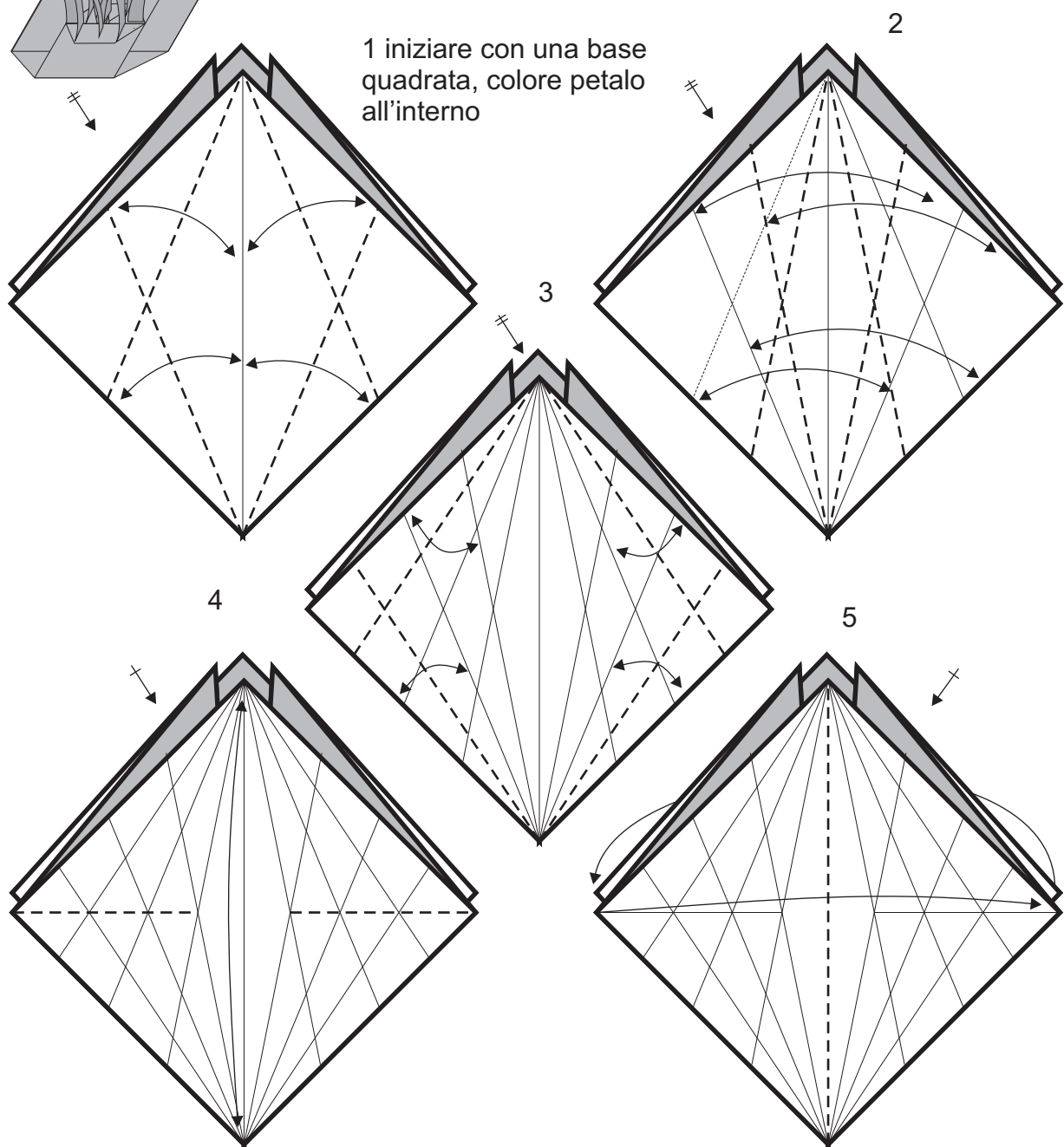

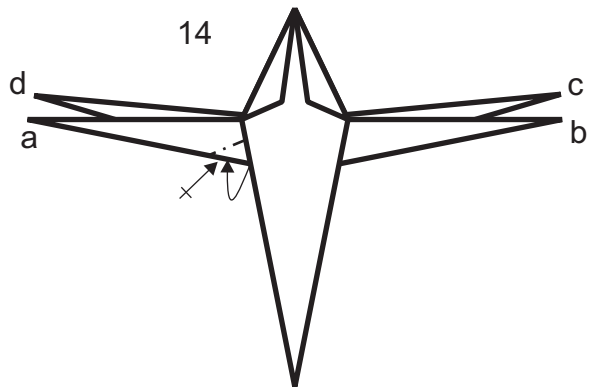
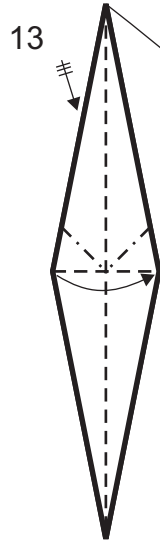
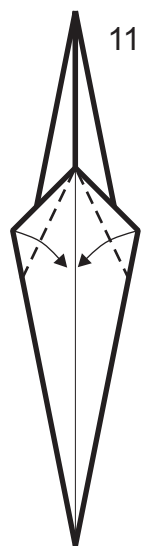
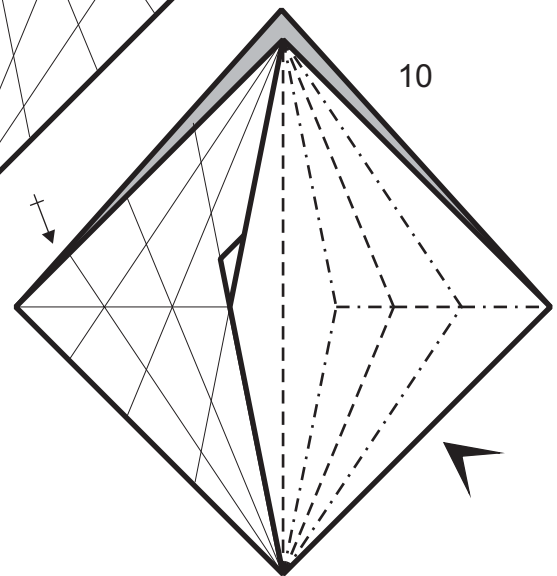
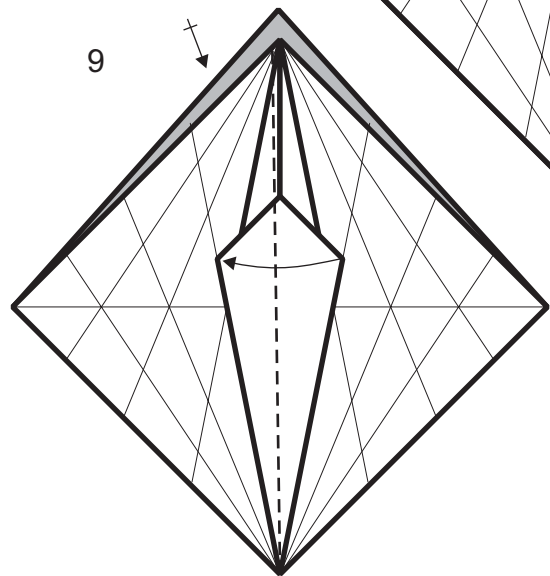
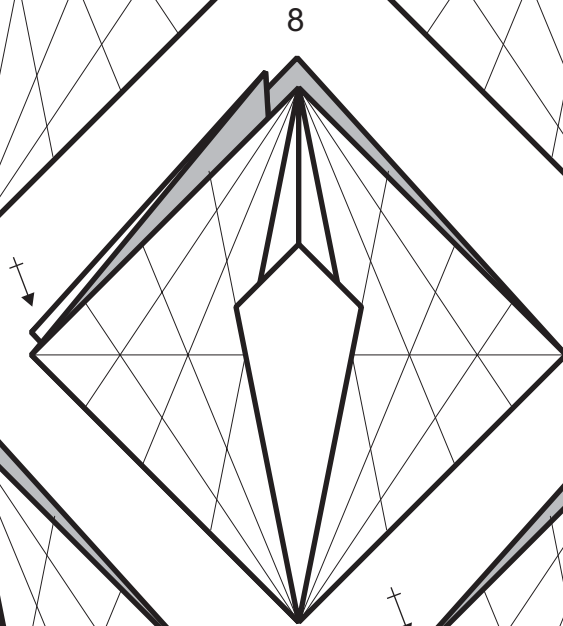
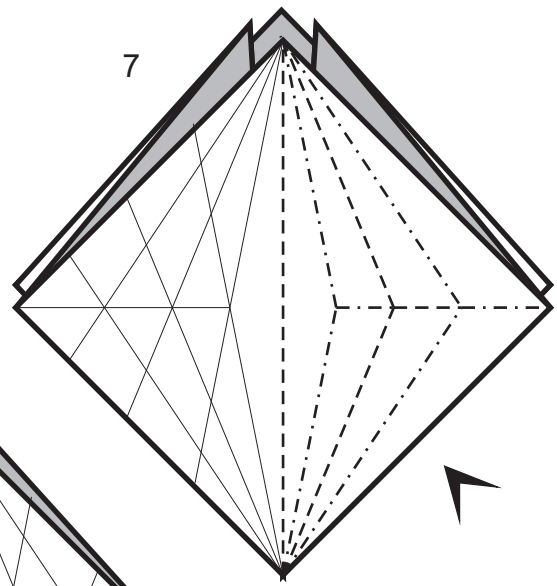
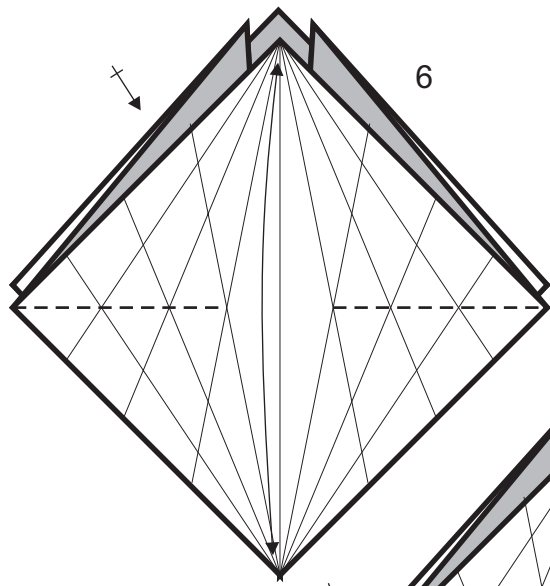



15 ripetere solo sulle punte b c, la punta d deve restare diversa dalle altre

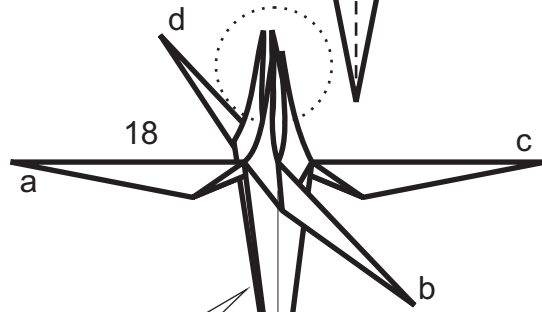
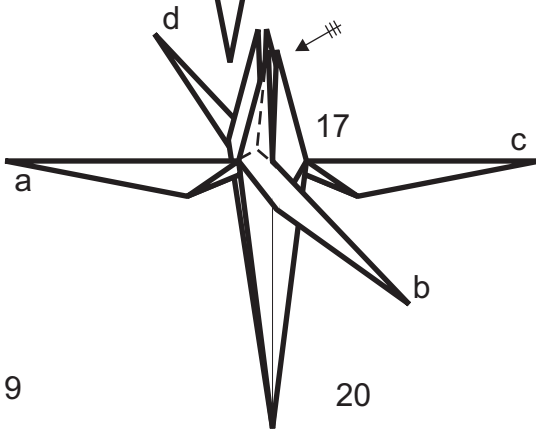
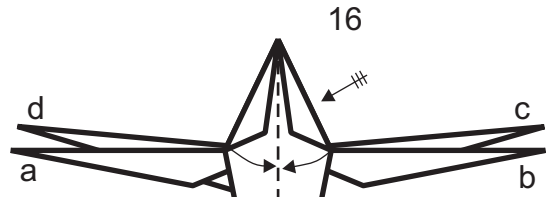

19

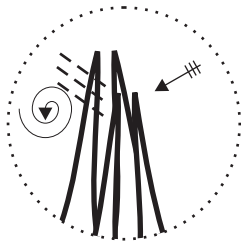

20

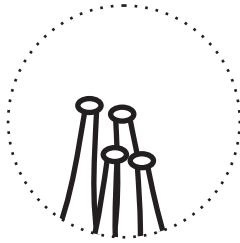

22 modellare i petali

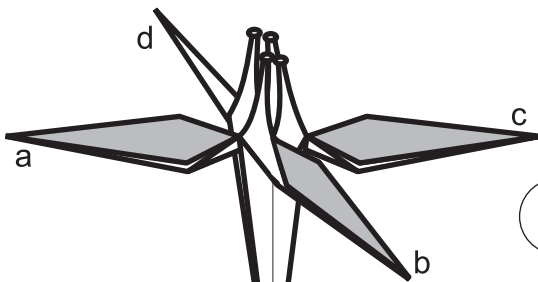

21

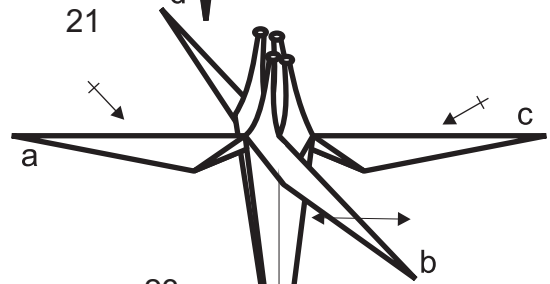

aprire solo uno strato

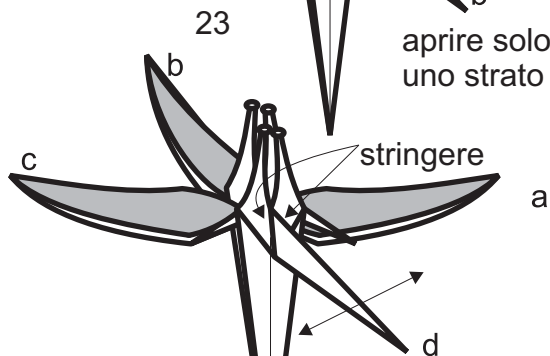

aprire tutti gli strati

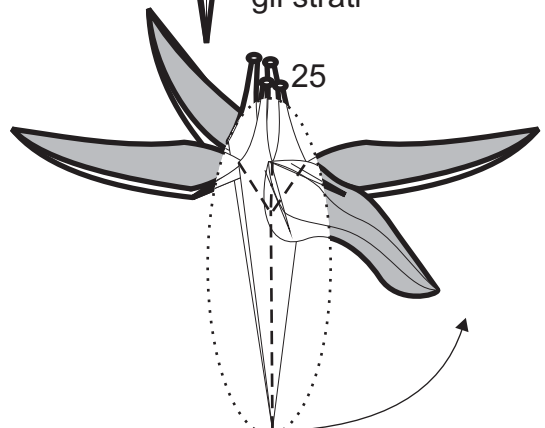
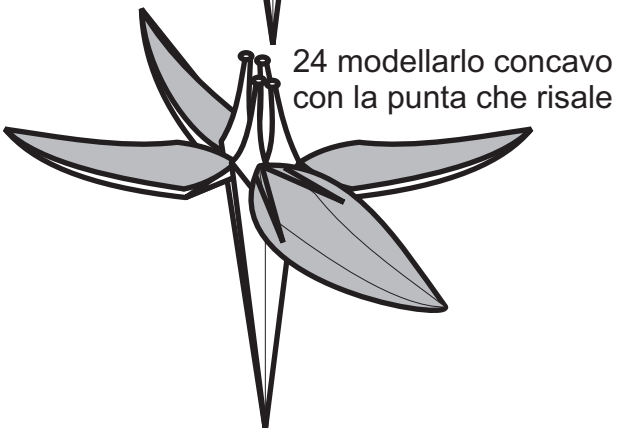

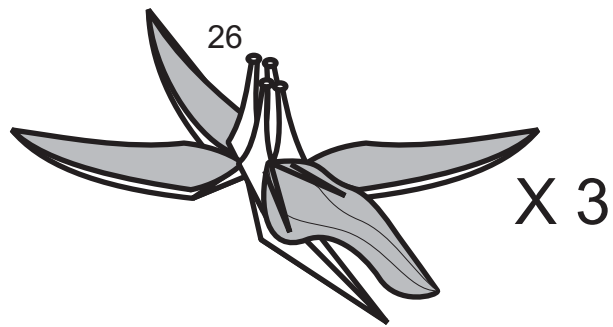

Erba

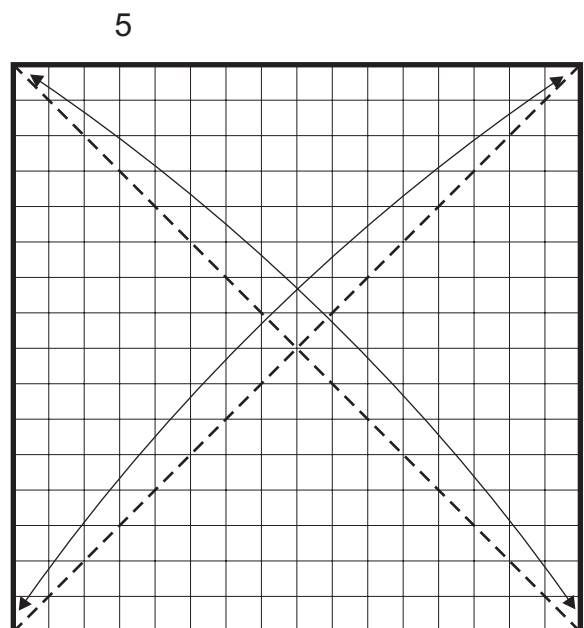
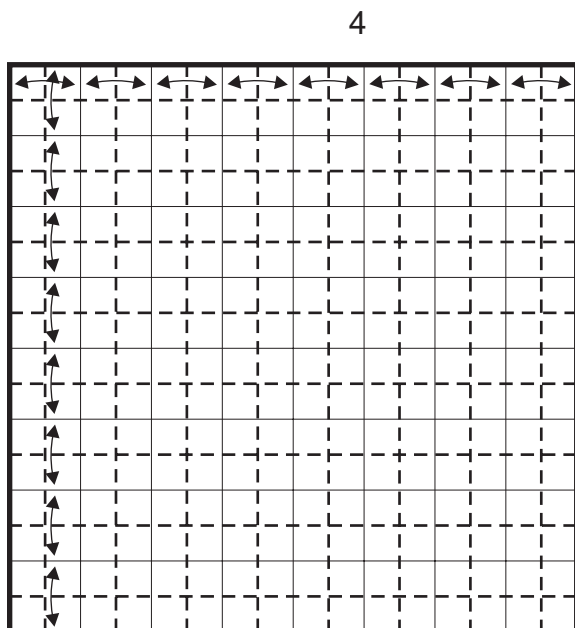
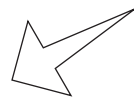
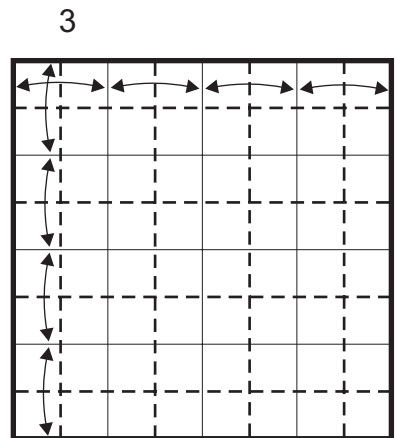
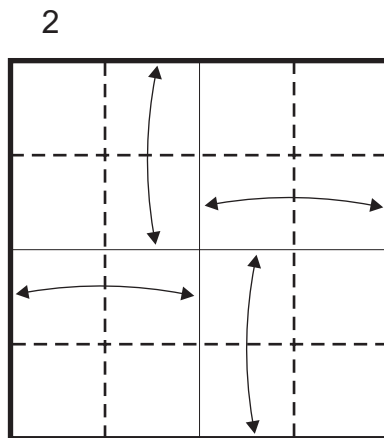
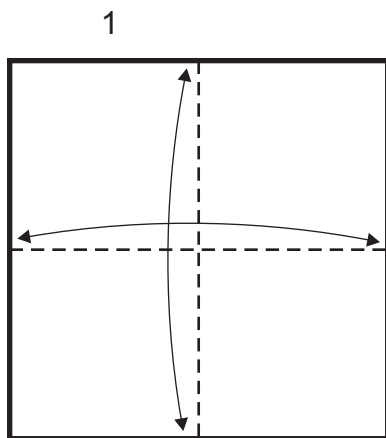

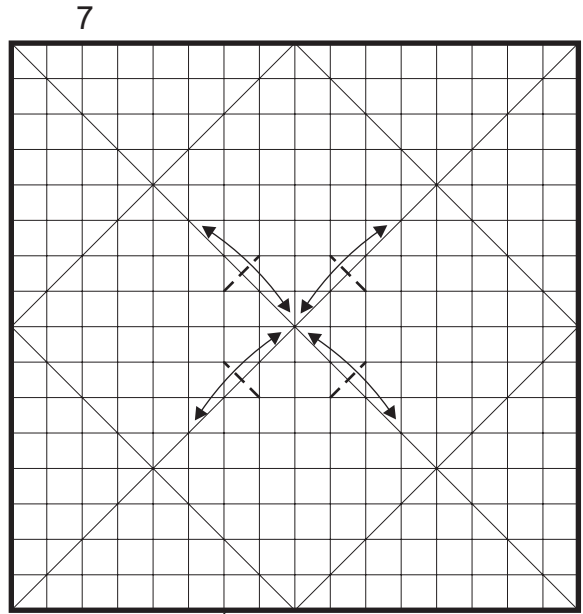
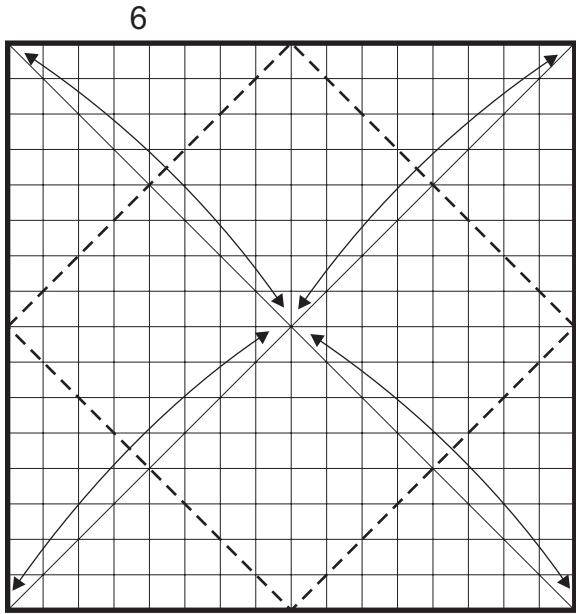

8

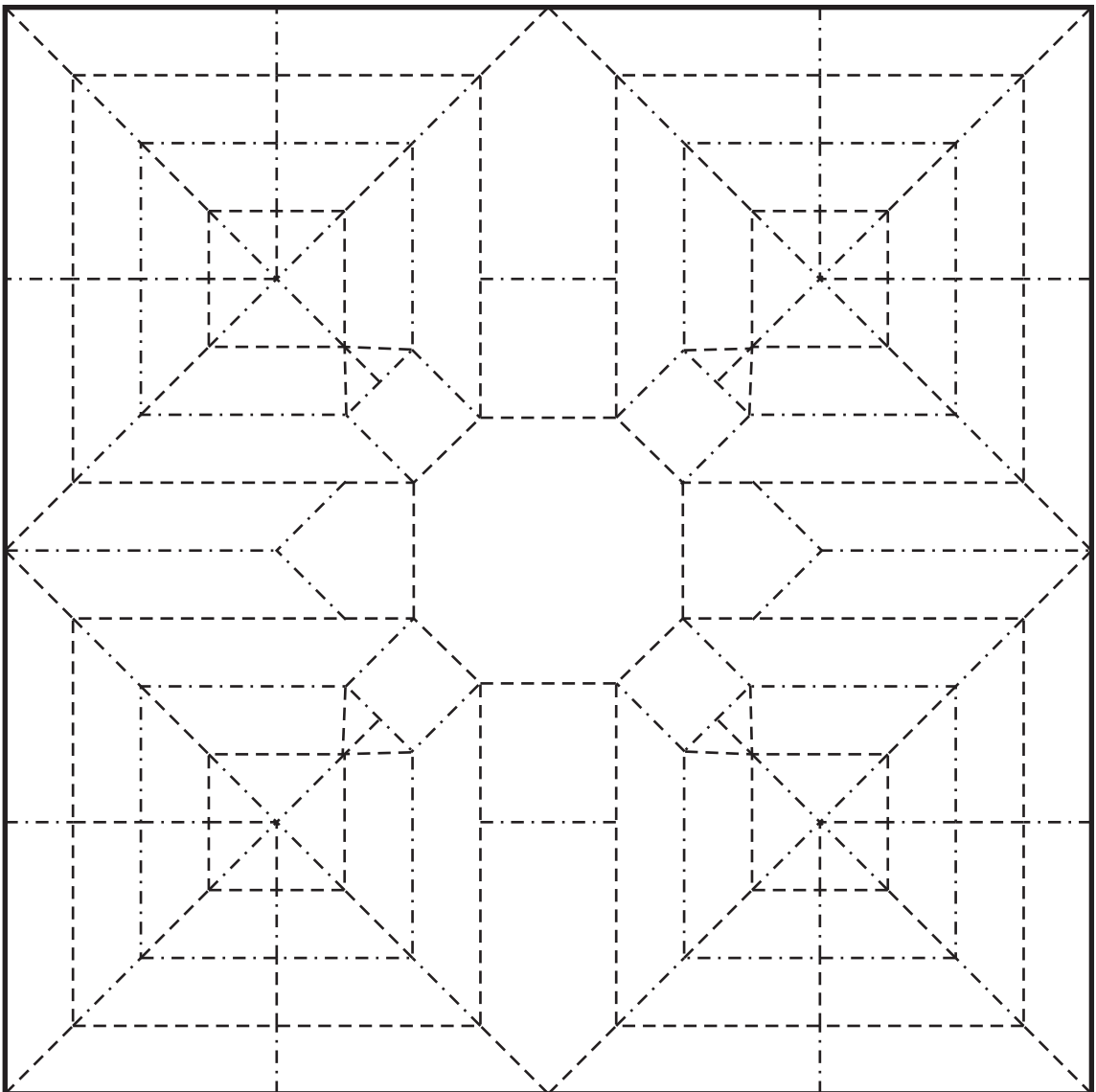

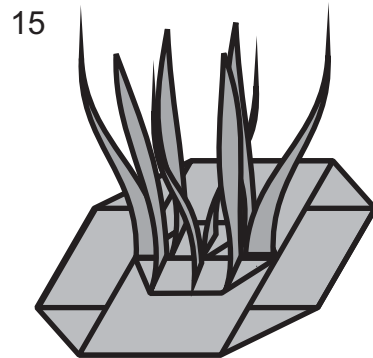
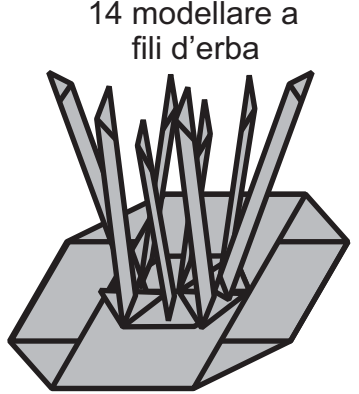
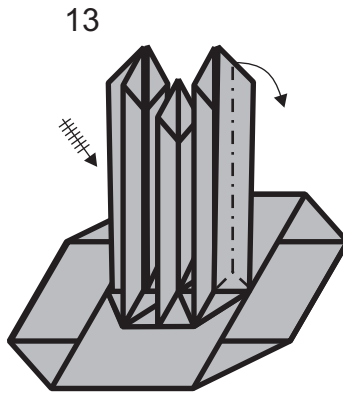
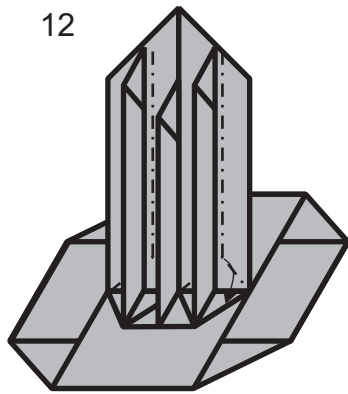
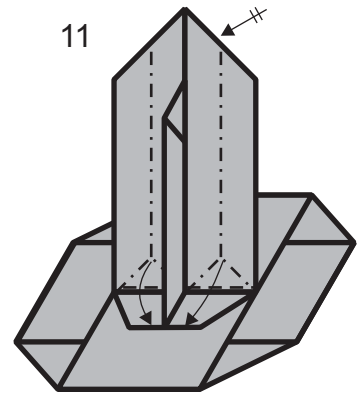
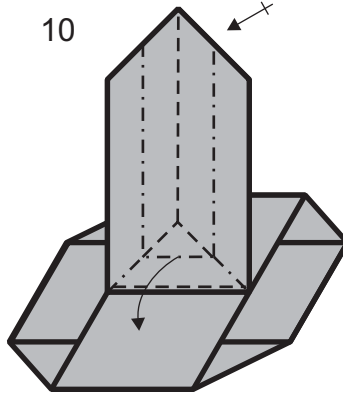
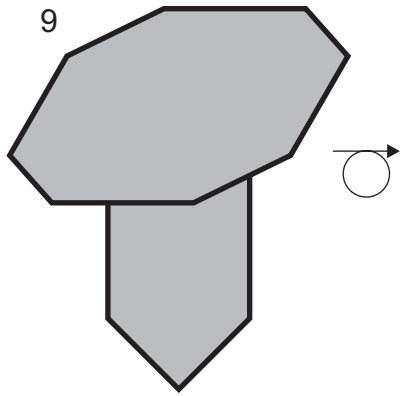

Foglia

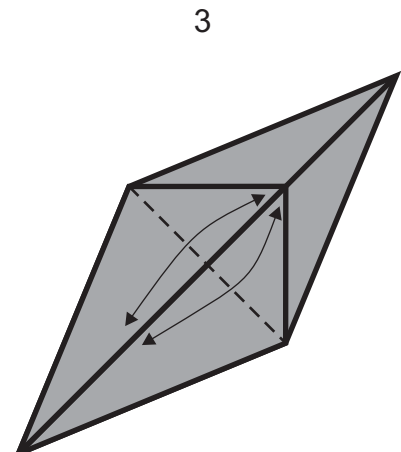
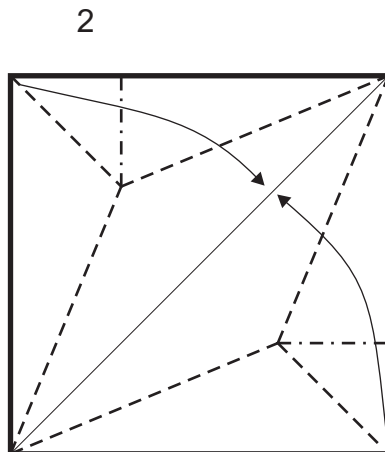
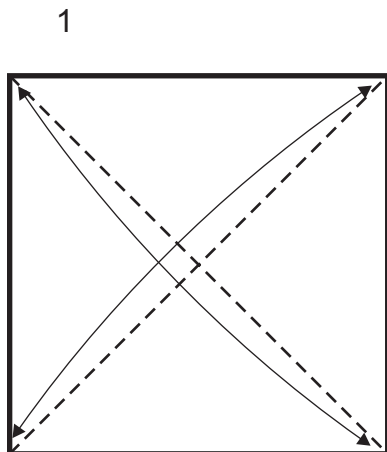

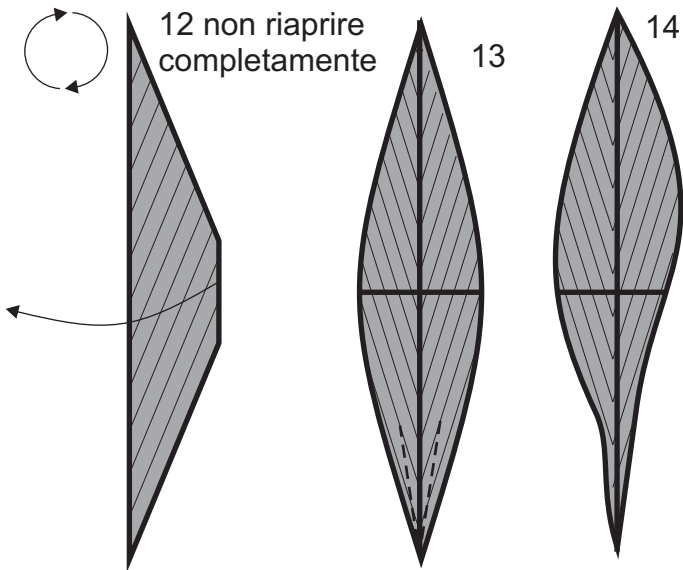
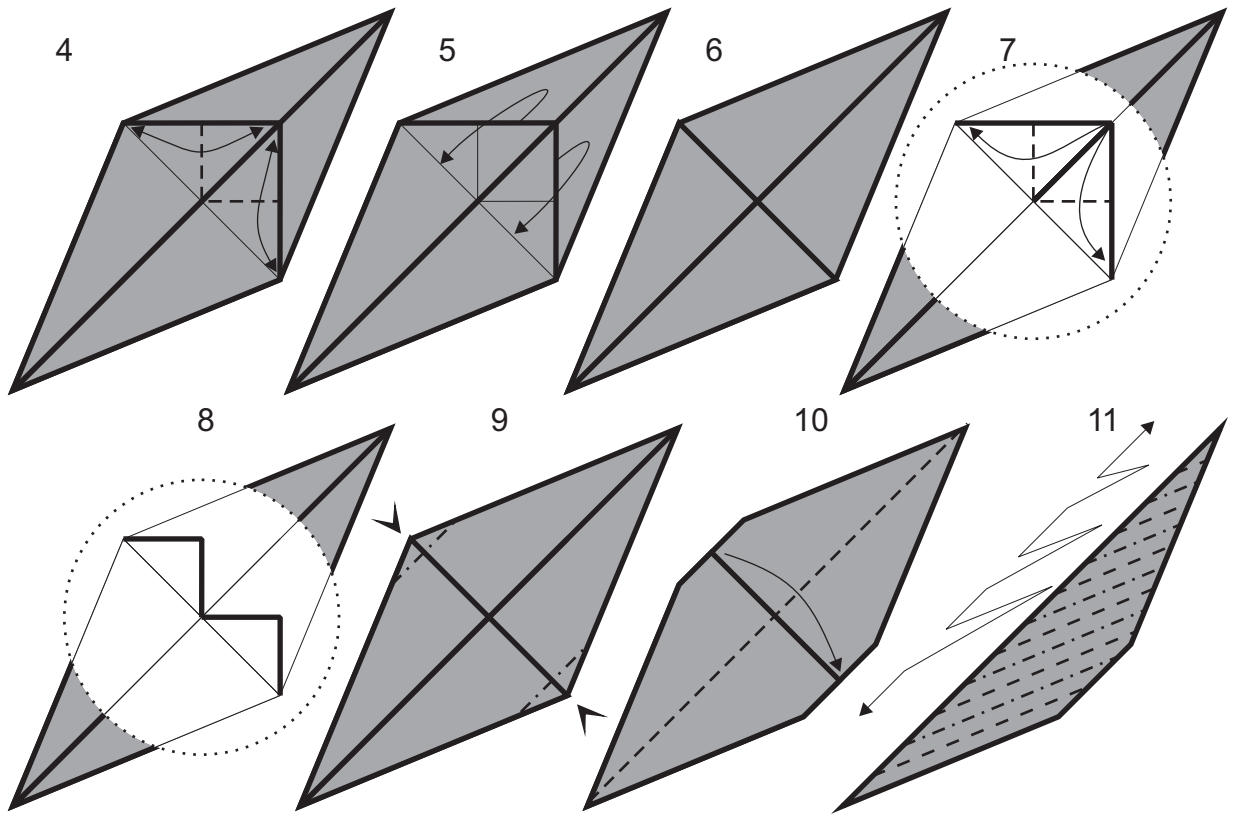

Stelo

2 riaprire 3/4

1 arrotolare

3

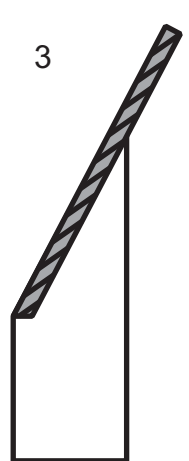

Montaggio

1 per rendere il tutto più solido si può usare dello scotch, ma non è indispensabile

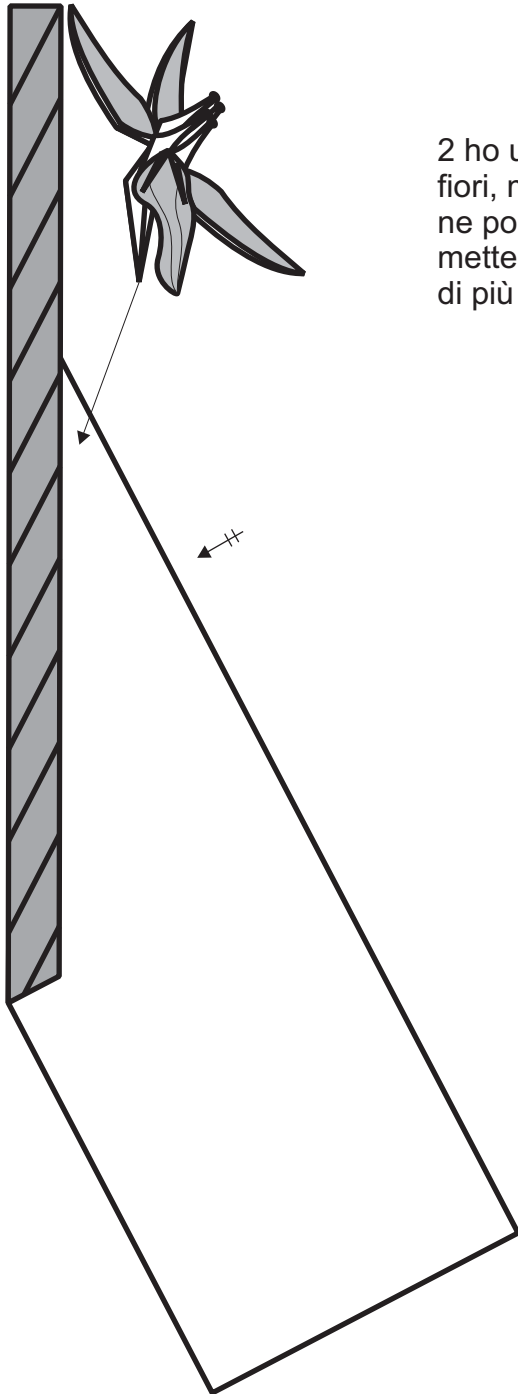

2 ho usato tre fiori, ma se ne possono mettere anche di più



schacciare e arrotolare



4 inserire e
poi modellare
lo stelo

perché questi fiori dovrebbero
poter partecipare a un concorso
fantasy?

perché sono OrchiDee!!!!

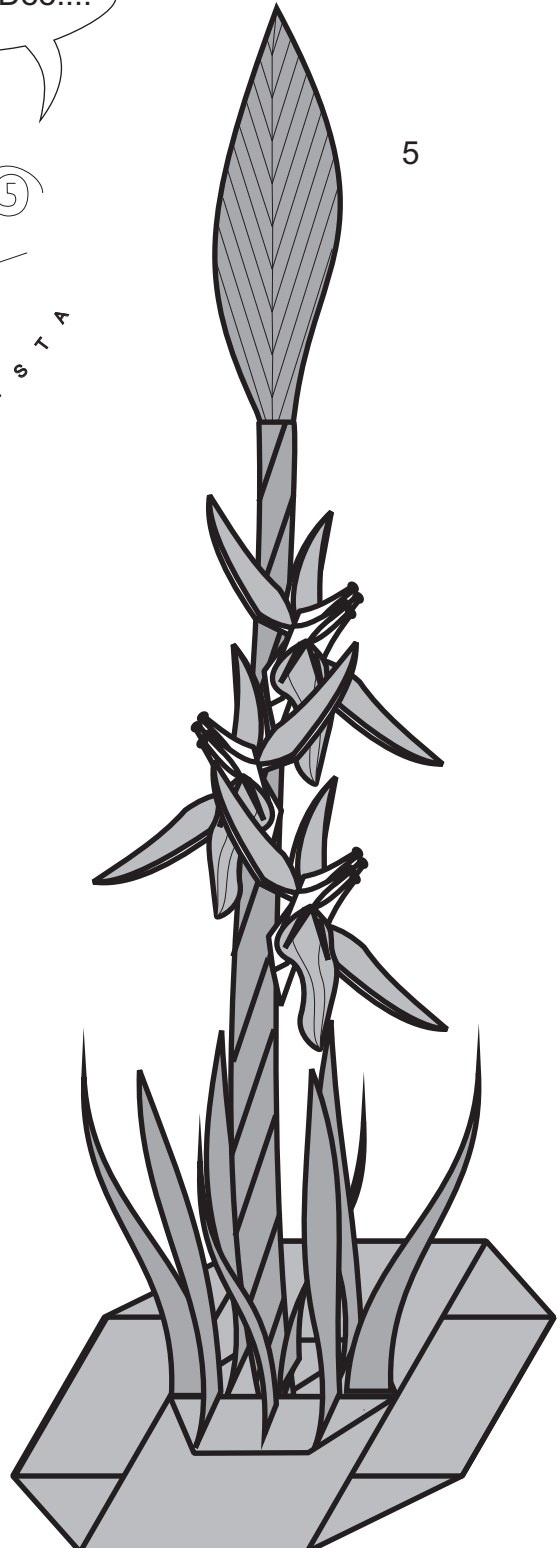
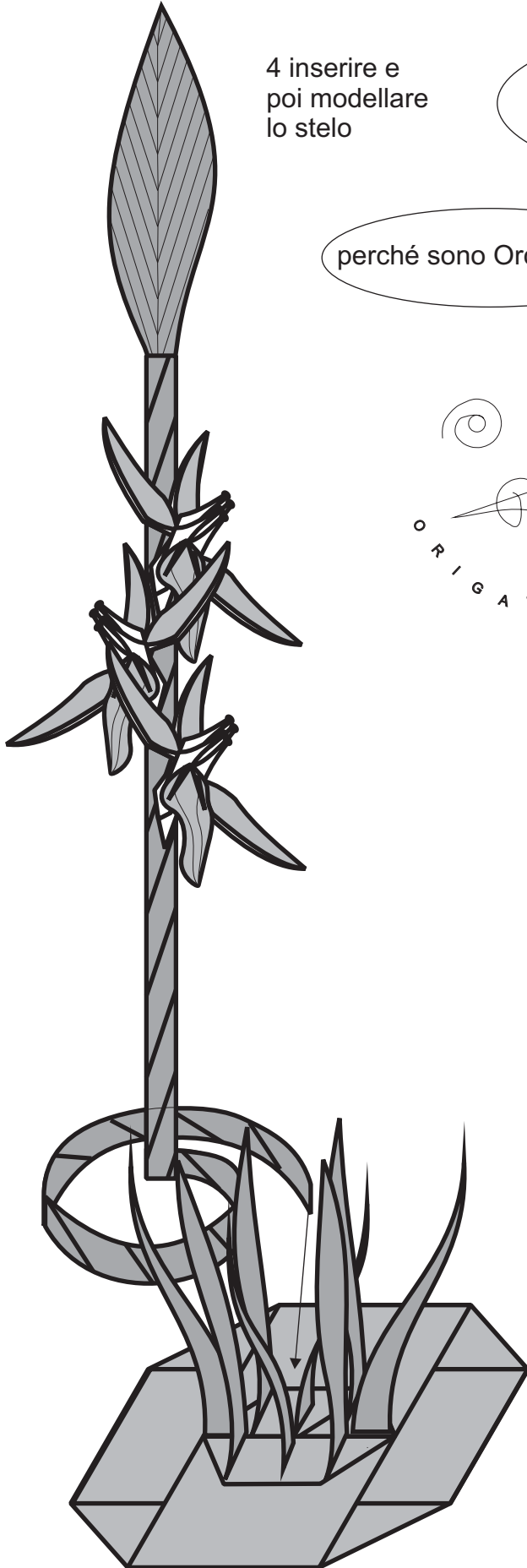

5