

Marabù maggiore

di P. D'Auria

Partire con la base quadrata, colore esterno

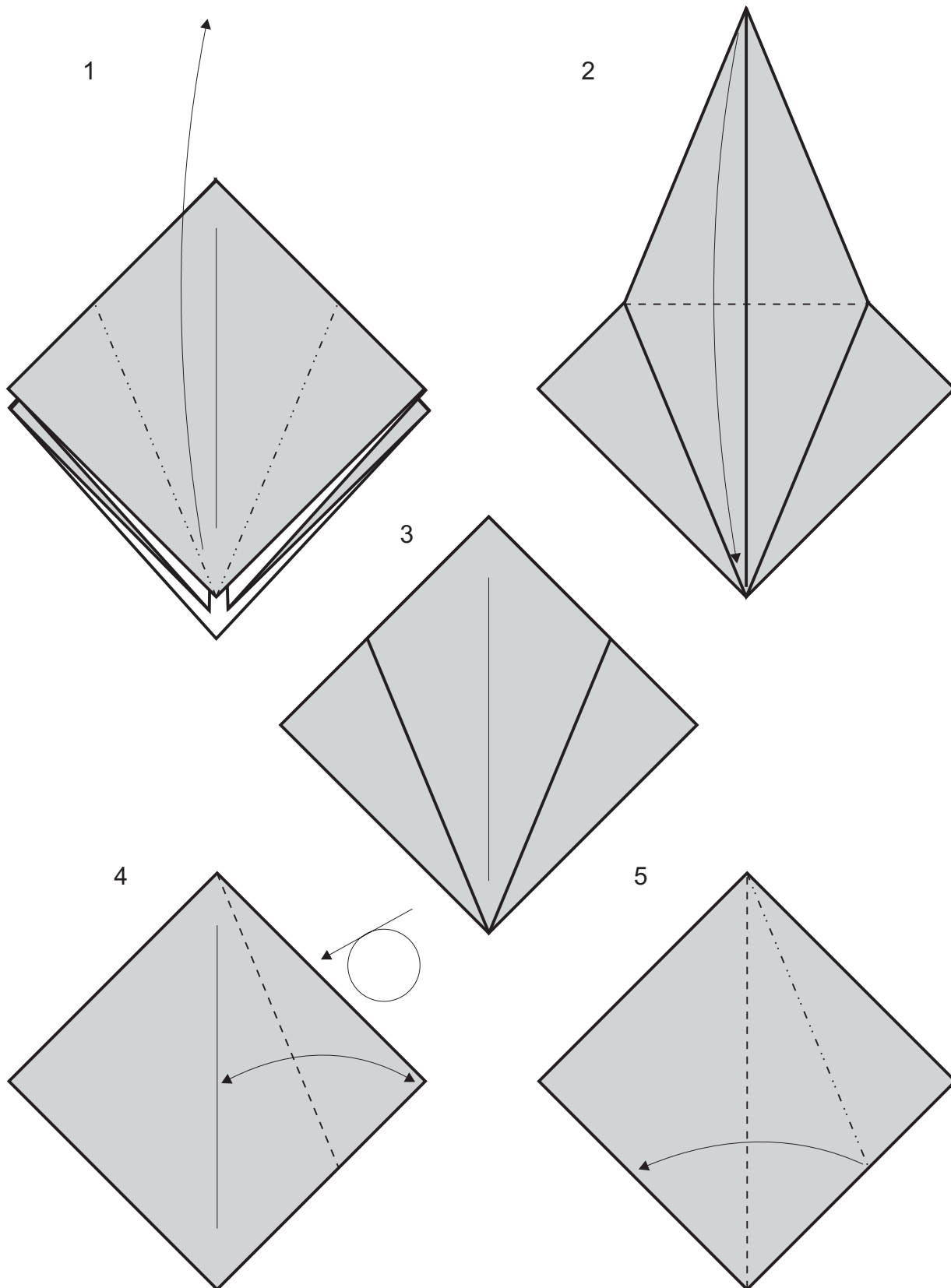

6

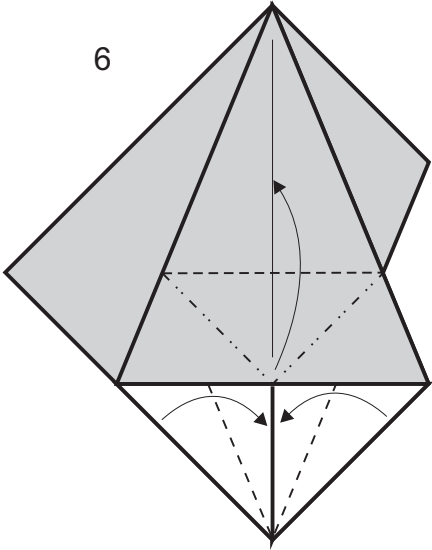

7 rivoltare il triangolo all'interno, con la punta verso l'alto

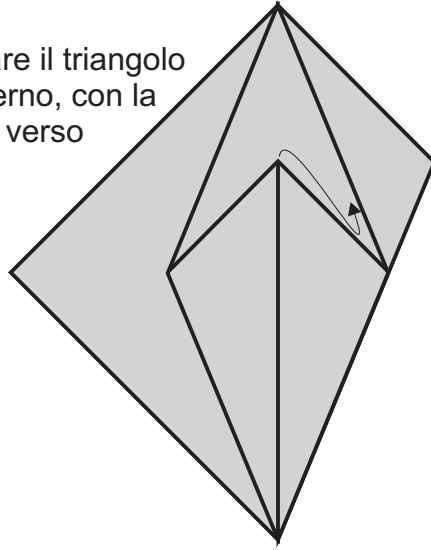

8

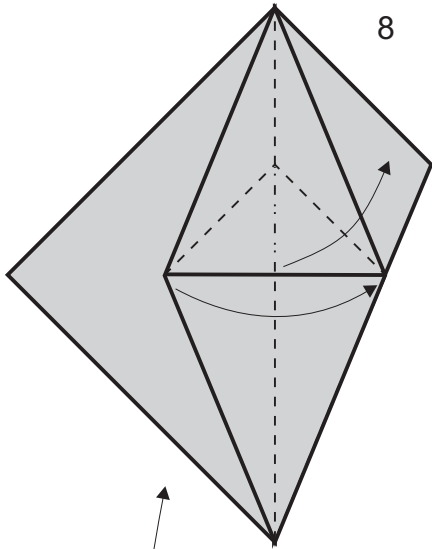

9 ripetere i passi da 4 a 8 dall'altro lato

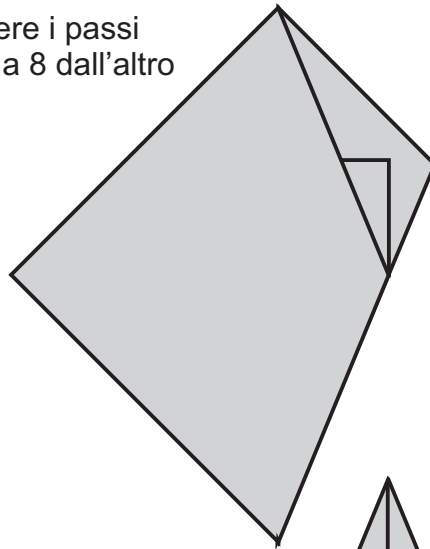

10

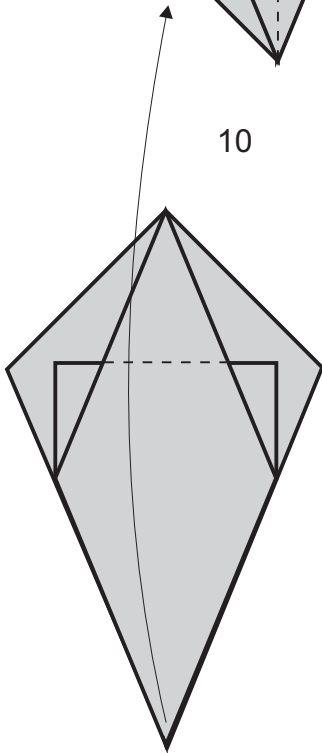

11

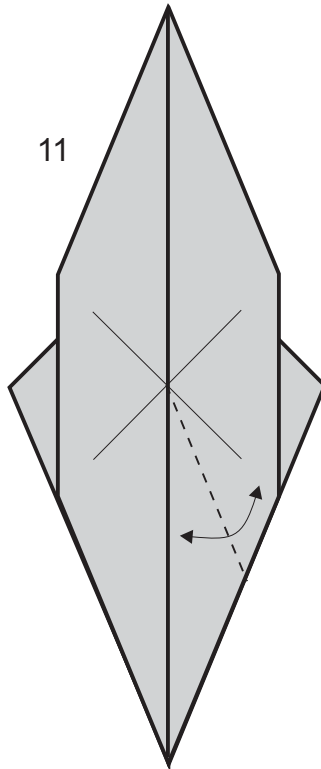

12

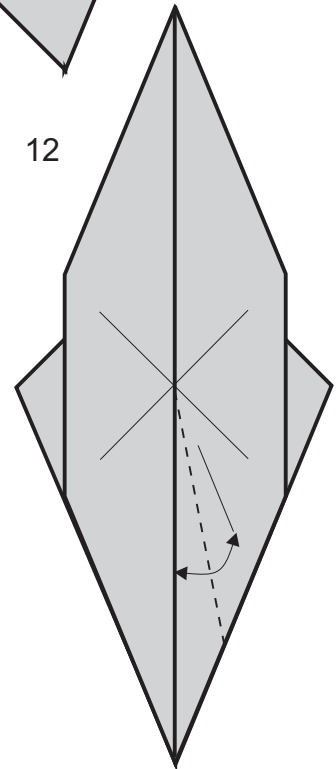

13

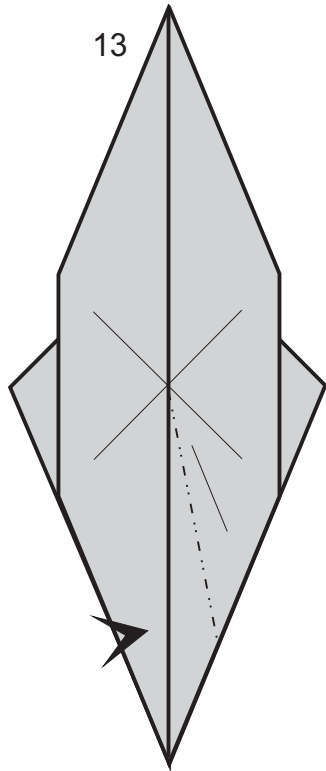

14

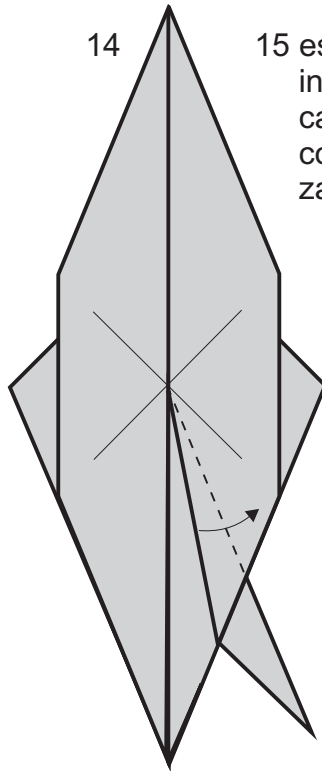

15 estrarre lo strato interno, cambiando il colore della zampa

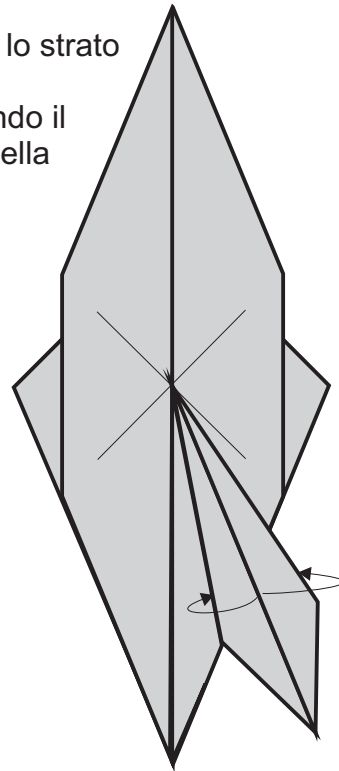

16

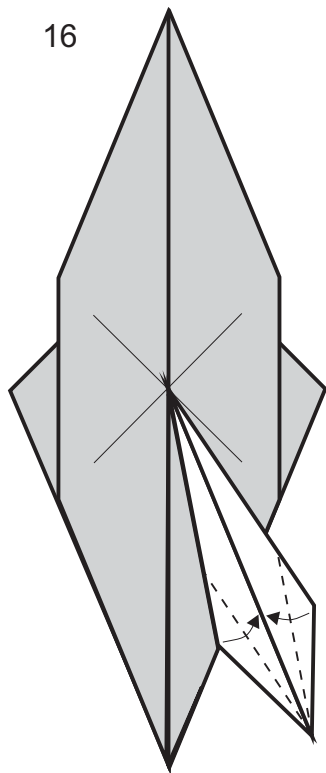

17

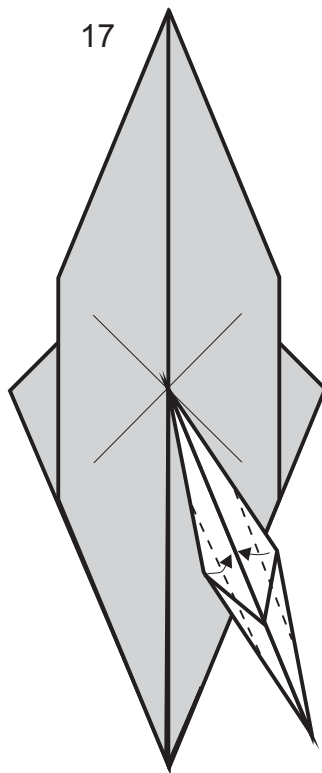

18

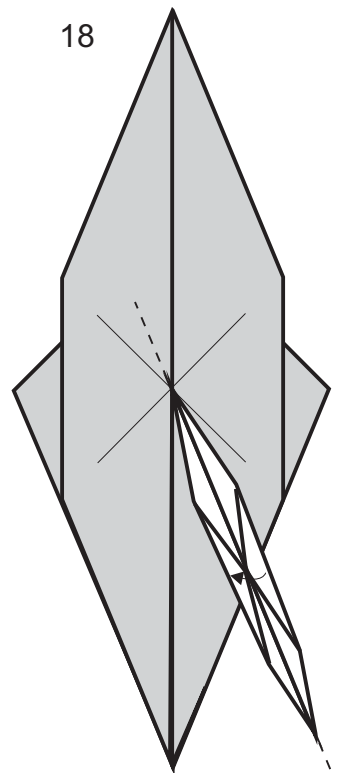

19

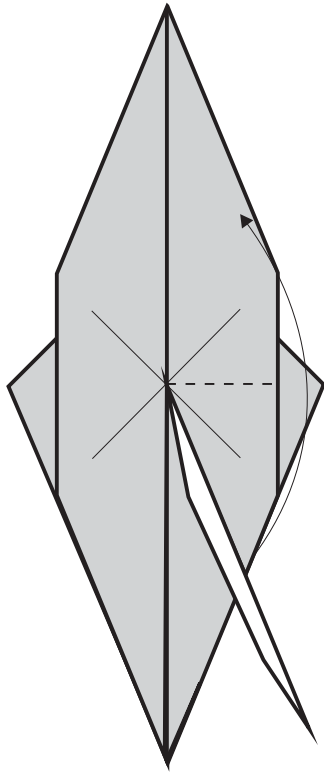

20 ripetere i passi
da 11 a 19 sull'altra
zampa

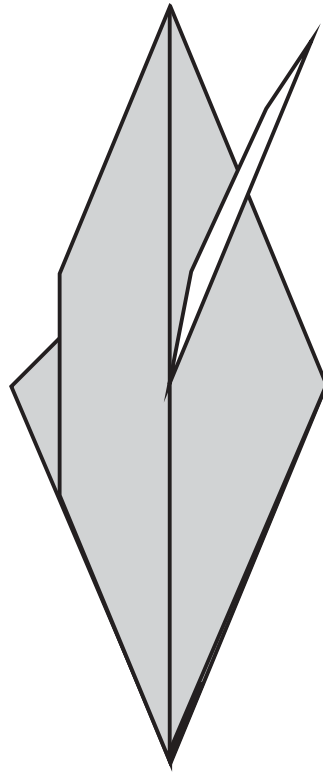

21

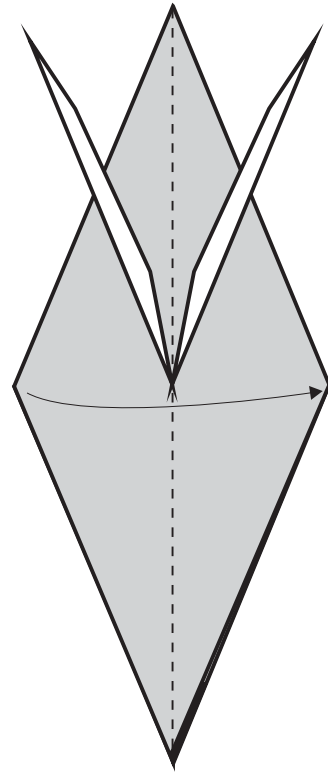

22

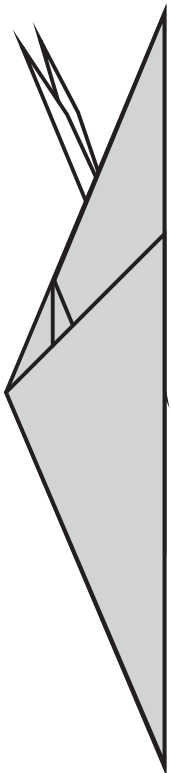

23

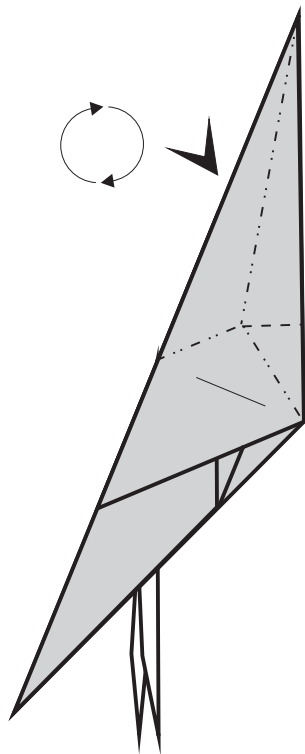

24

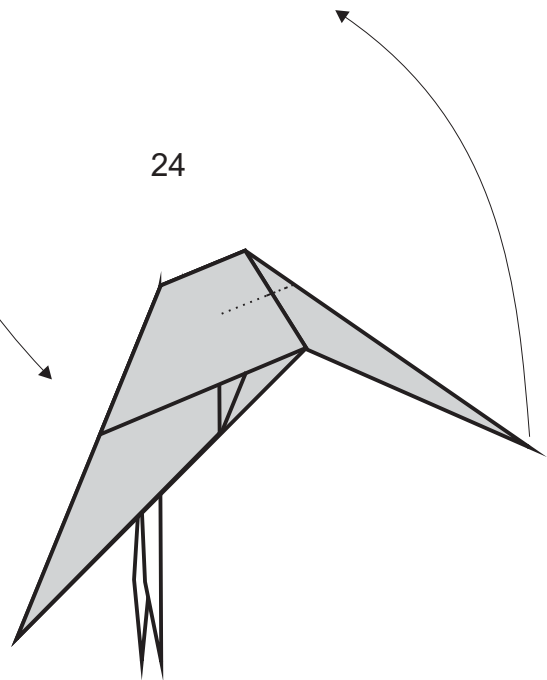

25

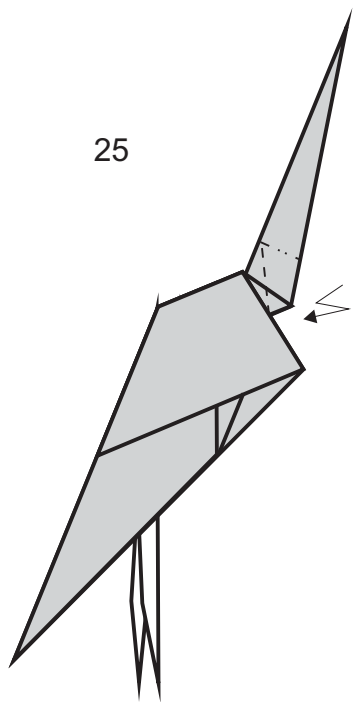

26 estrarre lo strato interno

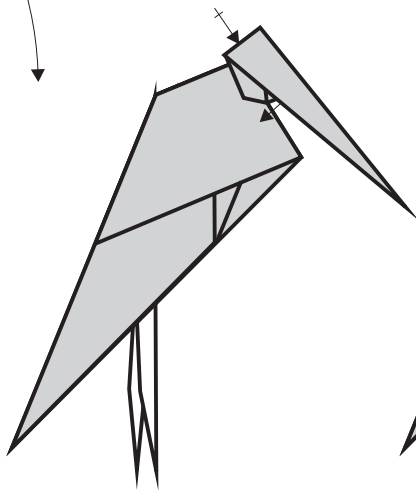

27

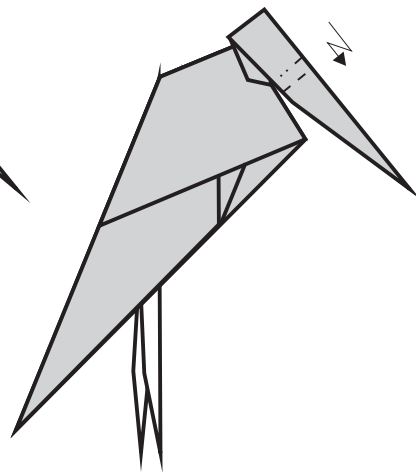

28

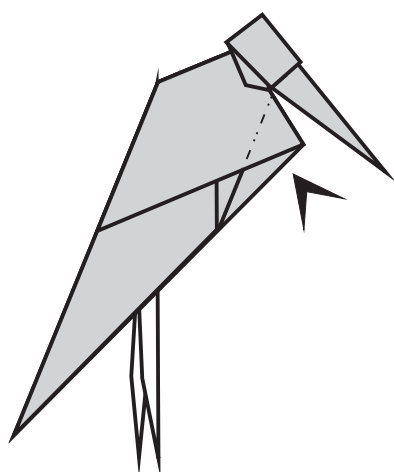

29 bloccare il modello

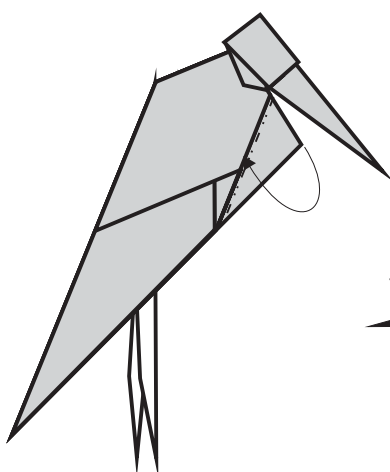

30

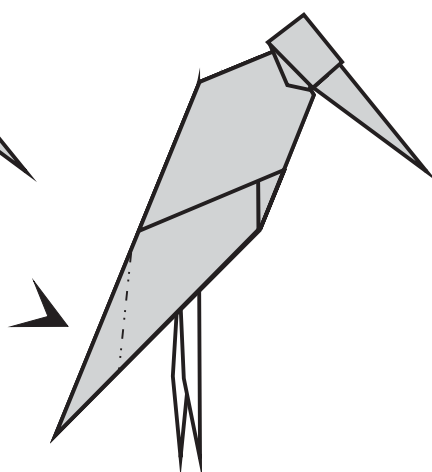

31

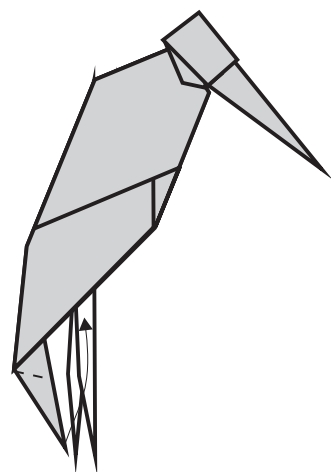

32

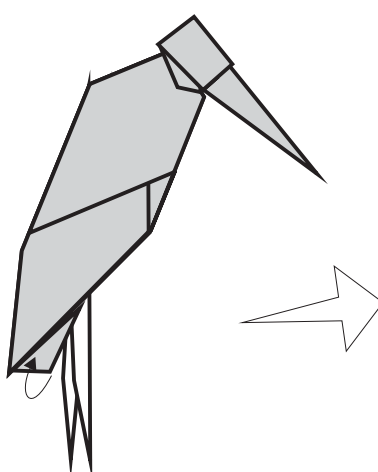

33

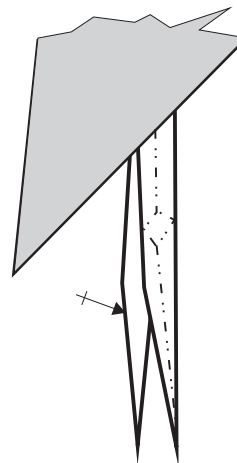

34

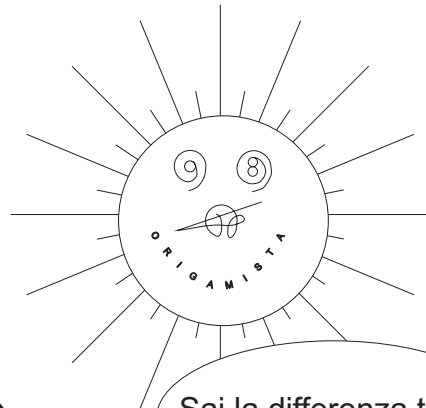
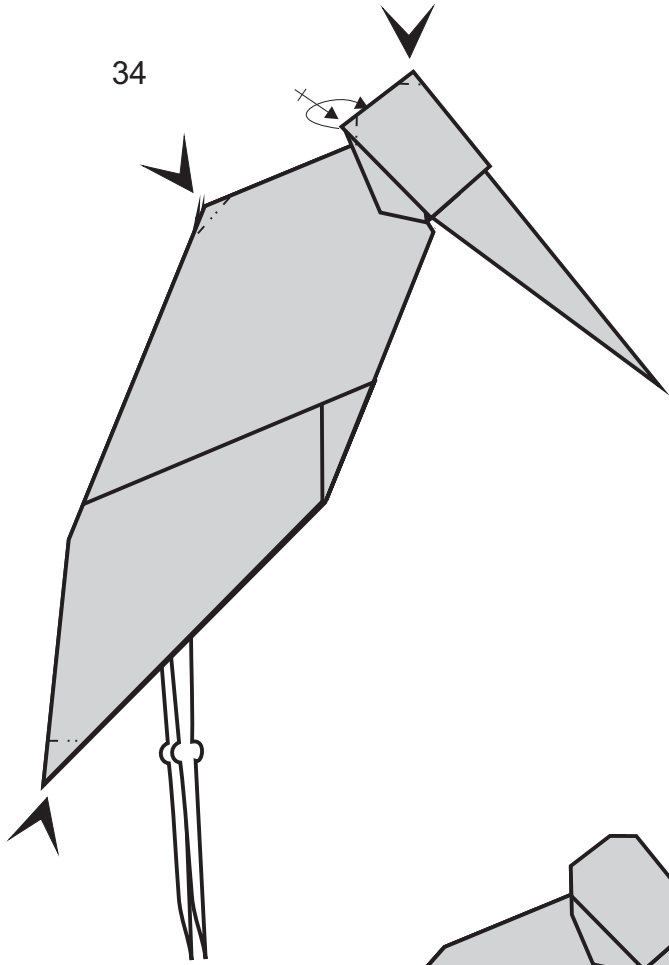

Sai la differenza tra un
pesce e una pietra?

No!

Stai molto
attento quando
mangi!

