

Abaco di P. D'Auria

<http://www.origamidauria.it>

Usare carta metallizzata

base

iniziare con un rettangolo 1X2

1 solo segnare il punto

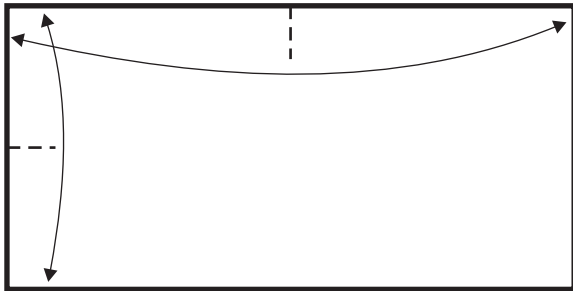

2

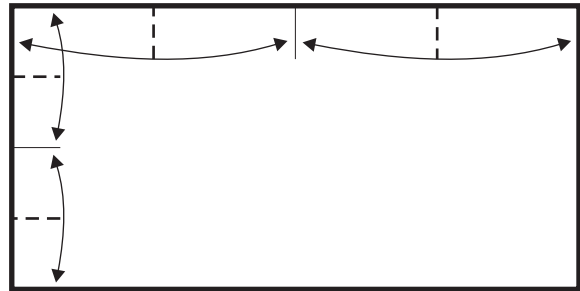

3

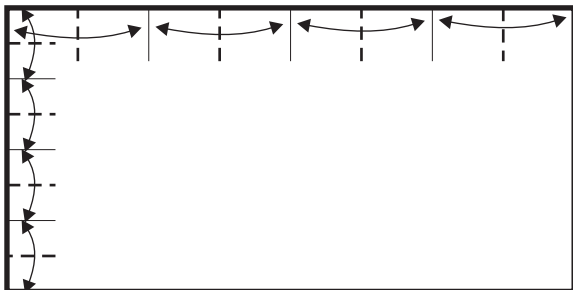

4

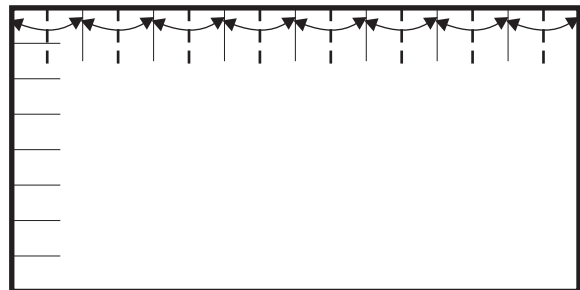

5

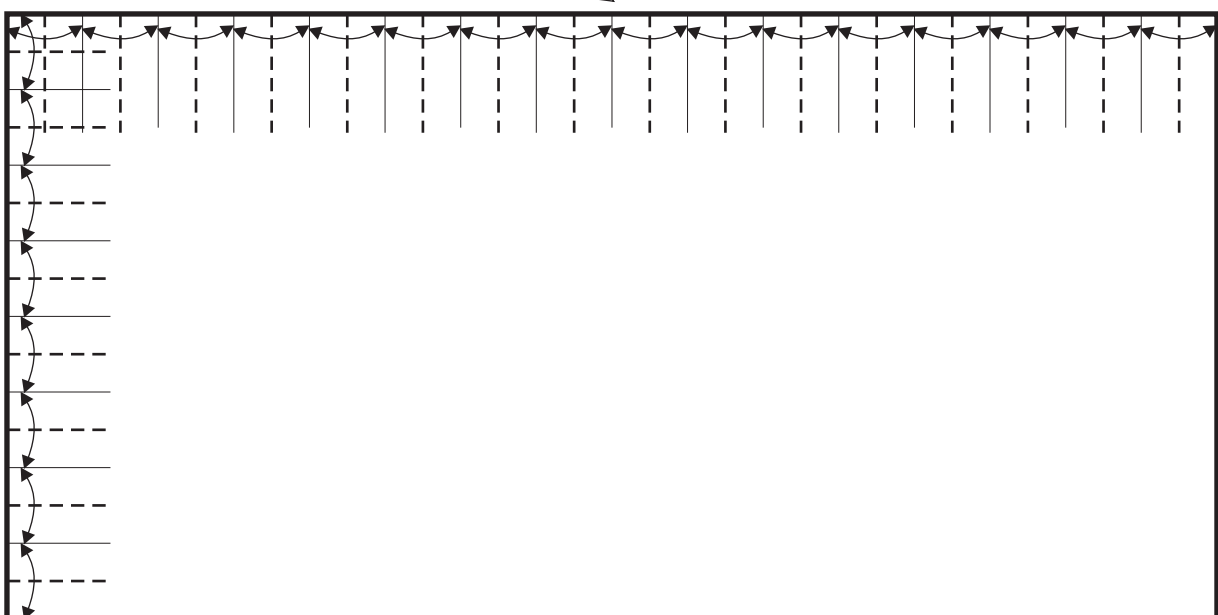

6

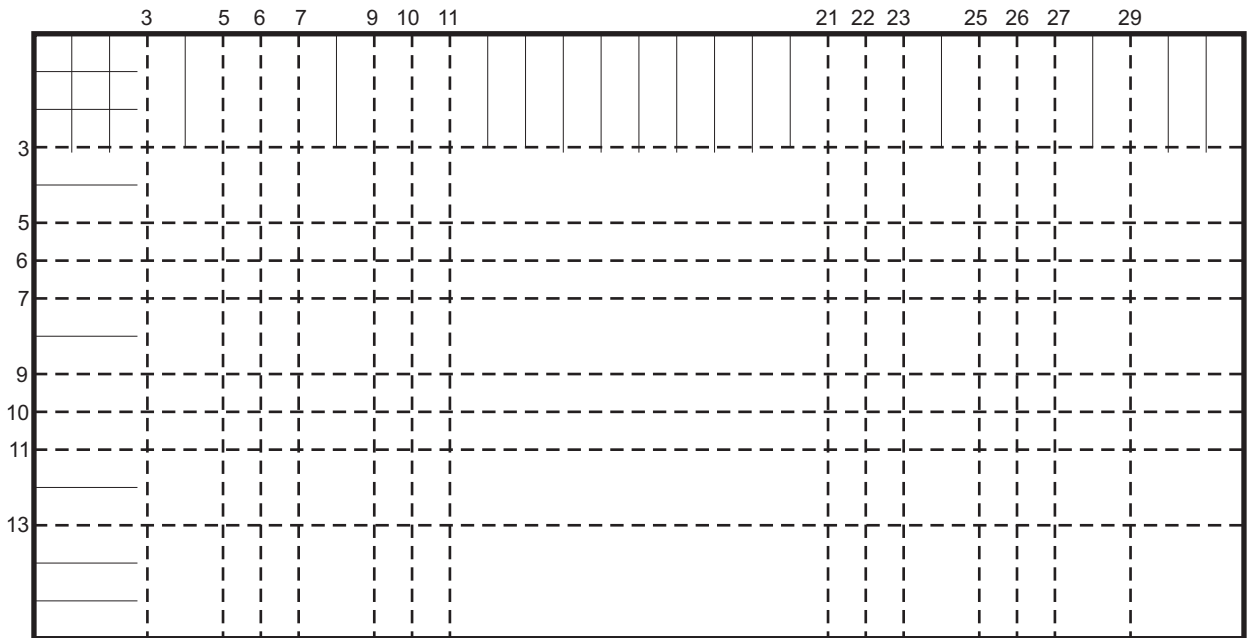

7

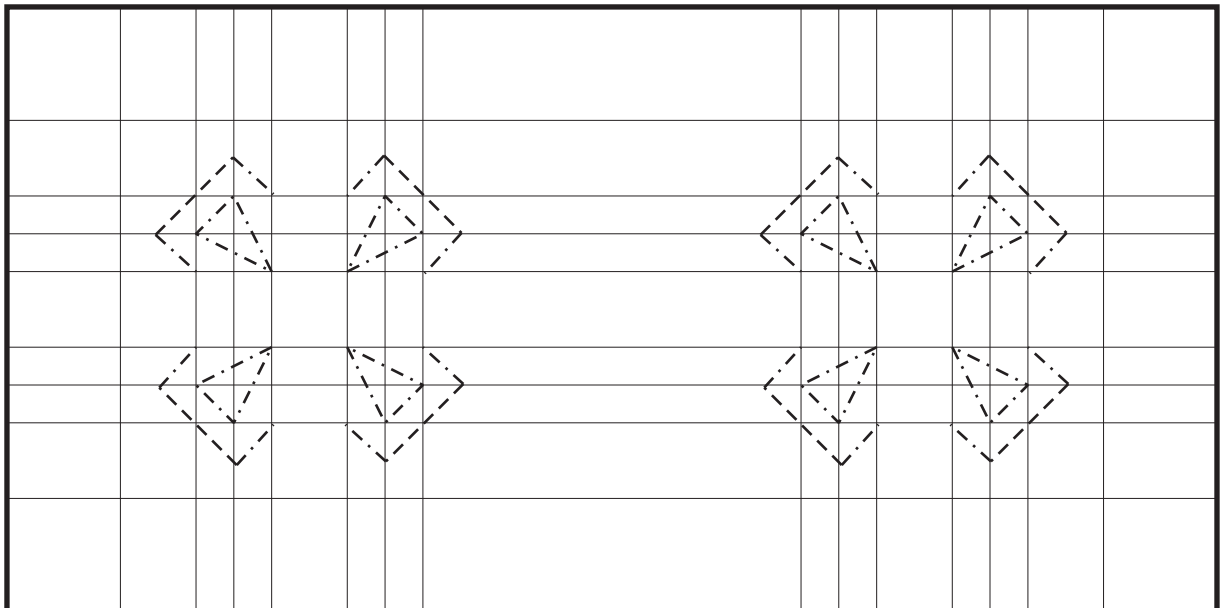

8

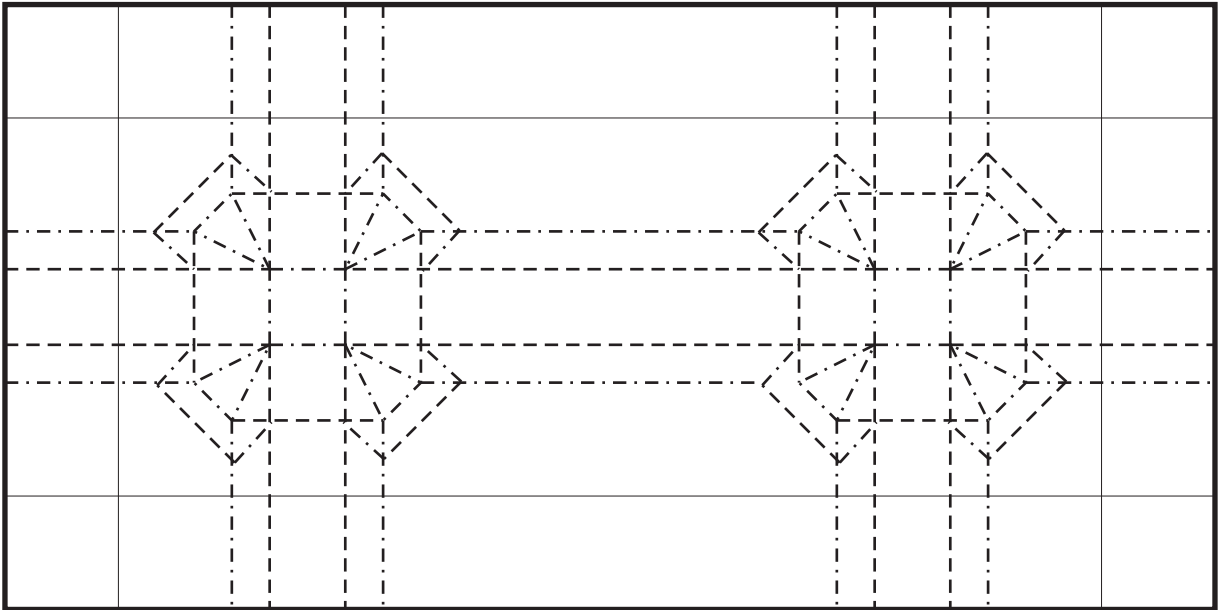

9

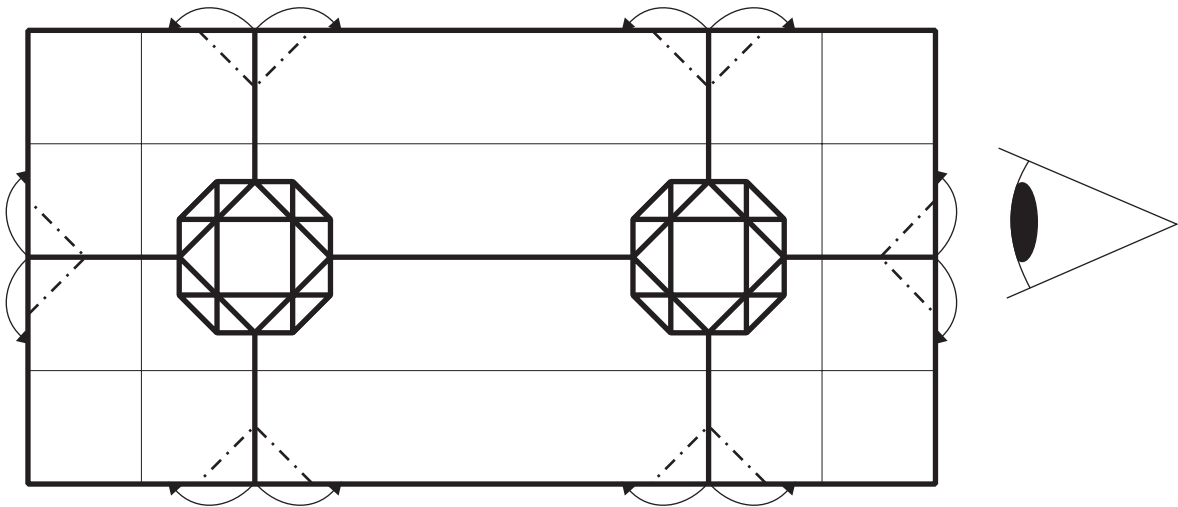

10

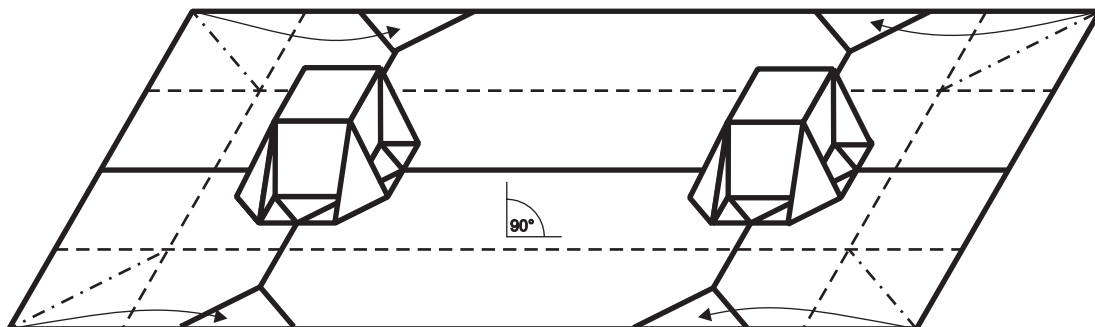

11

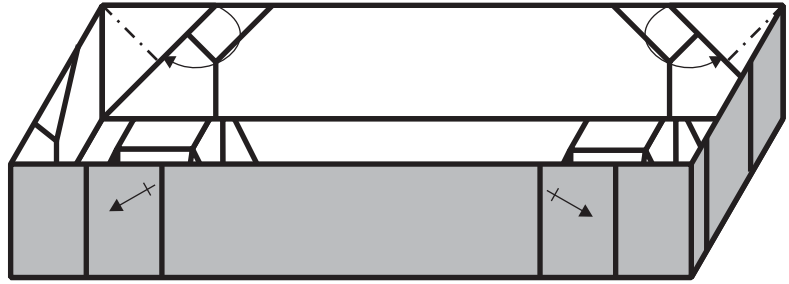

12

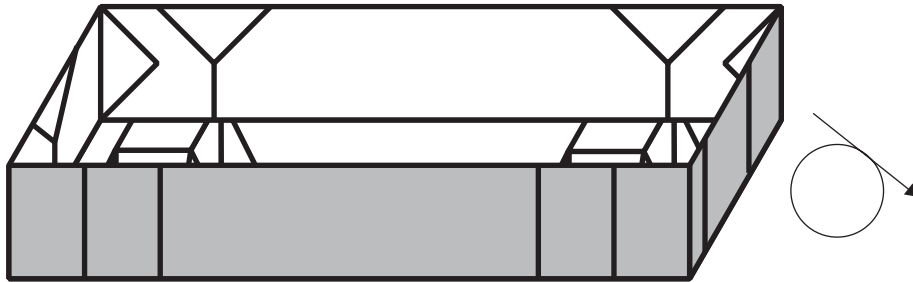

13



Pilastrino

iniziare con un rettangolo 12X27.

0

27

32

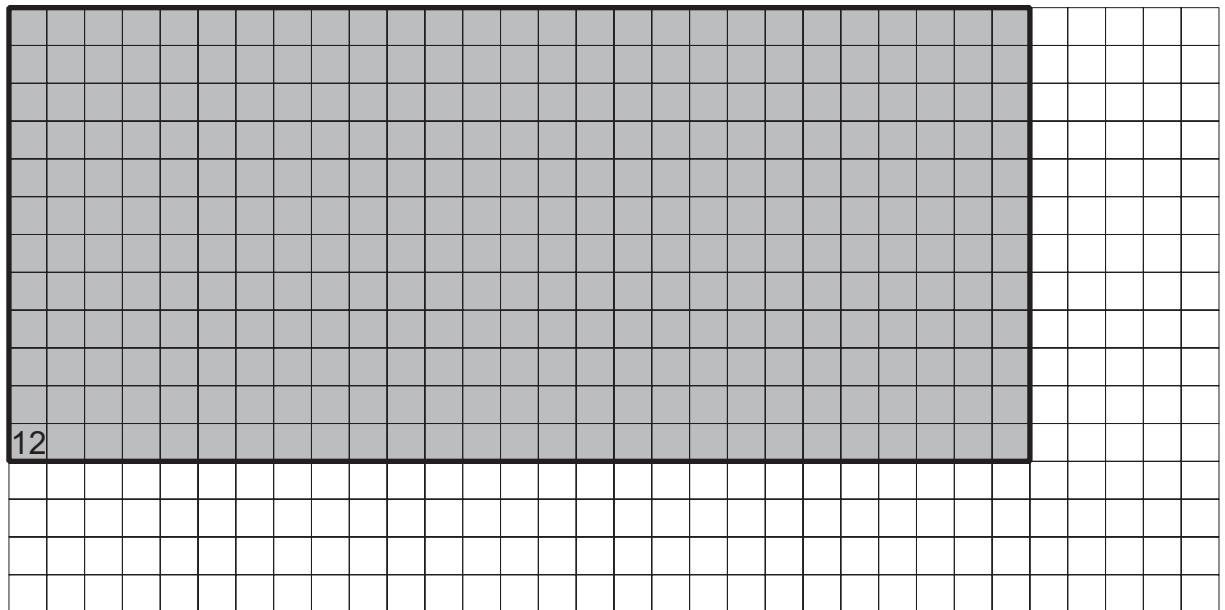

12

16

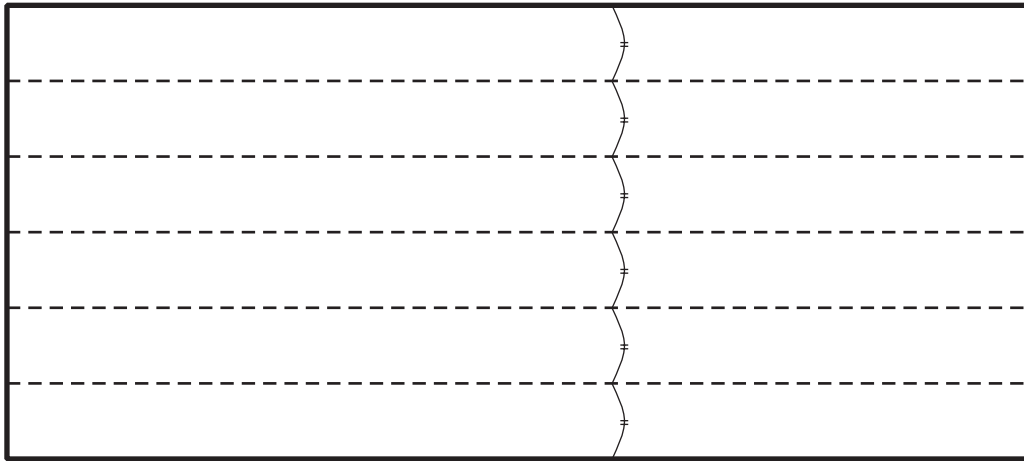

14

15

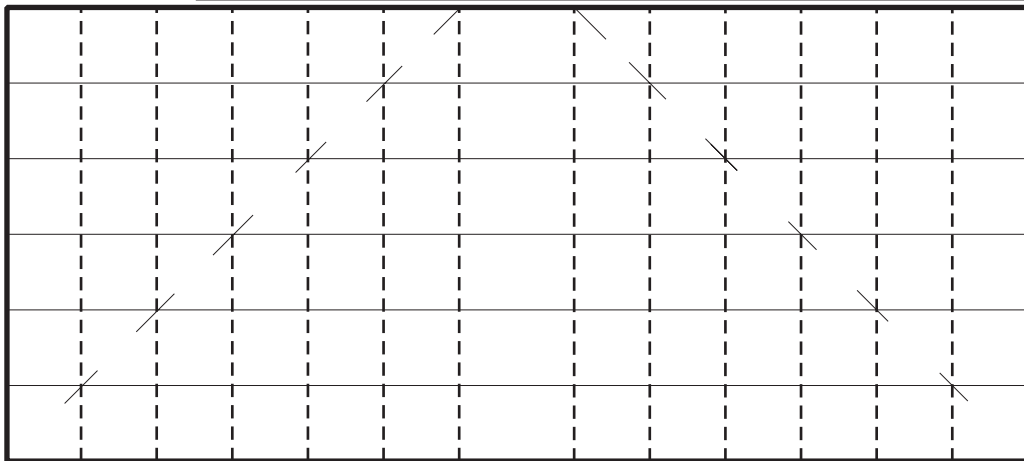
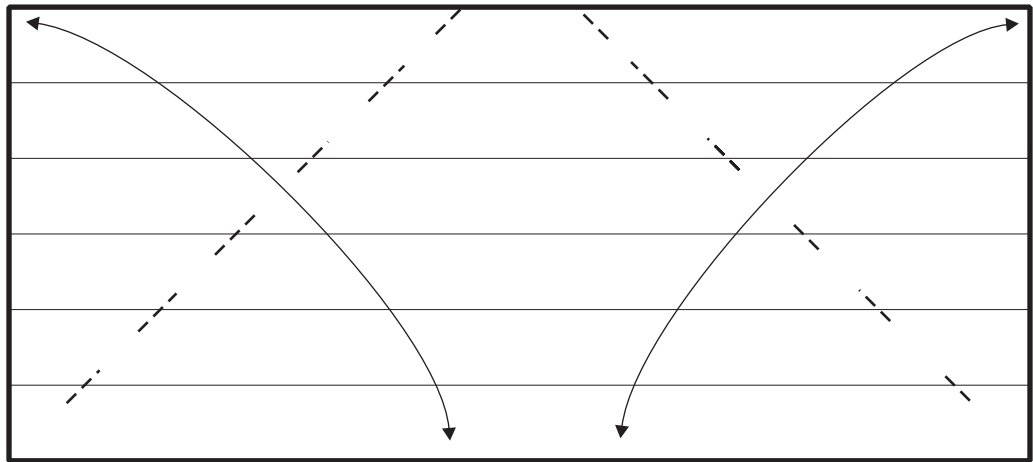

16

17

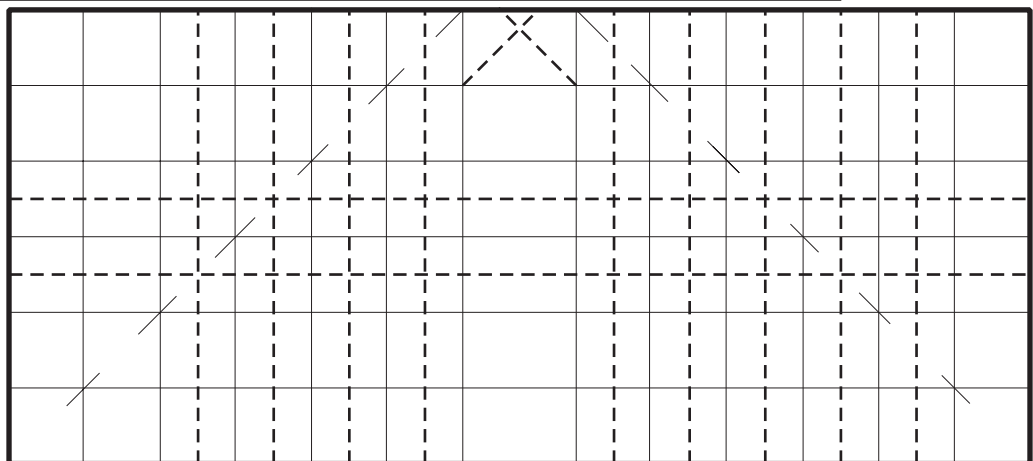

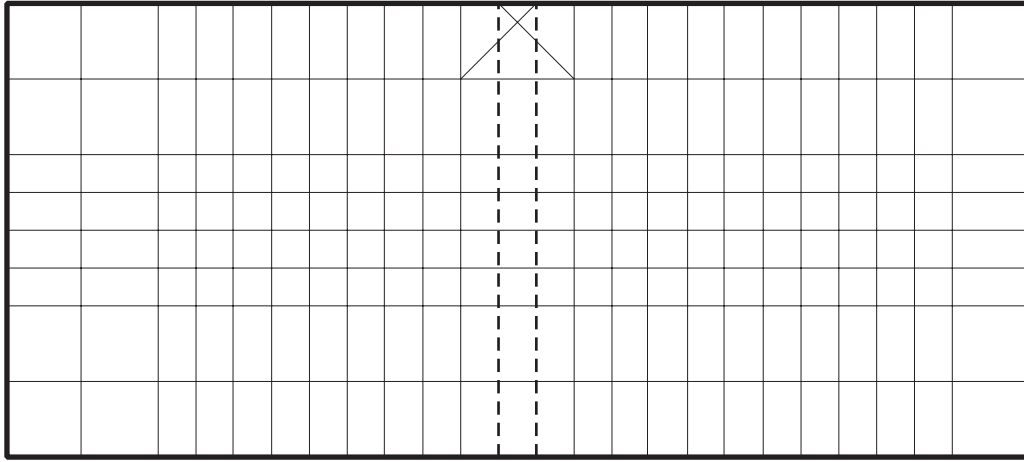

18

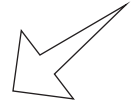

19

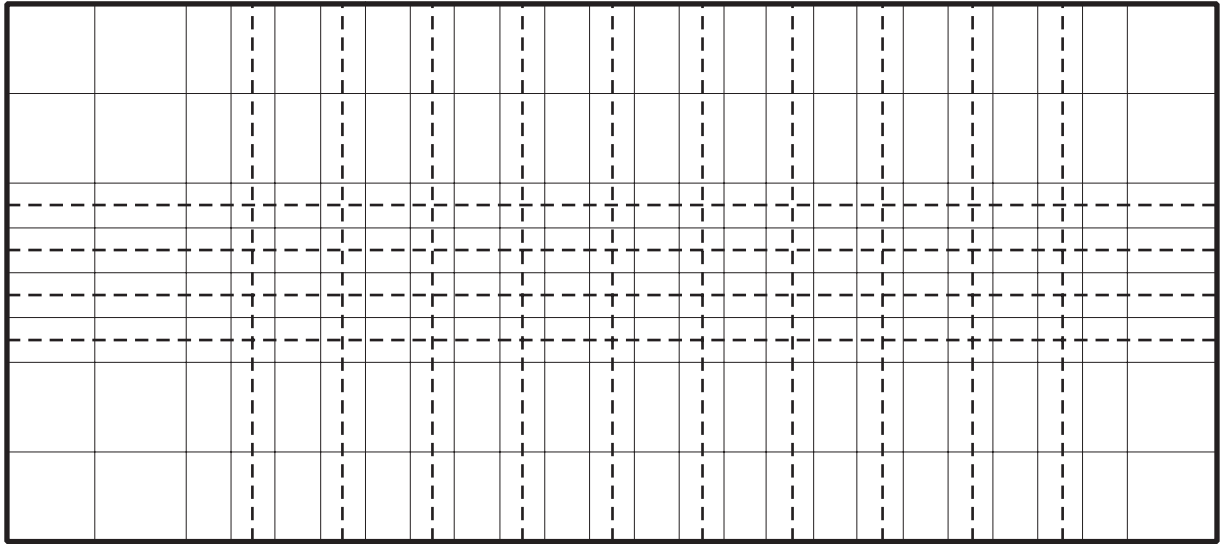

20

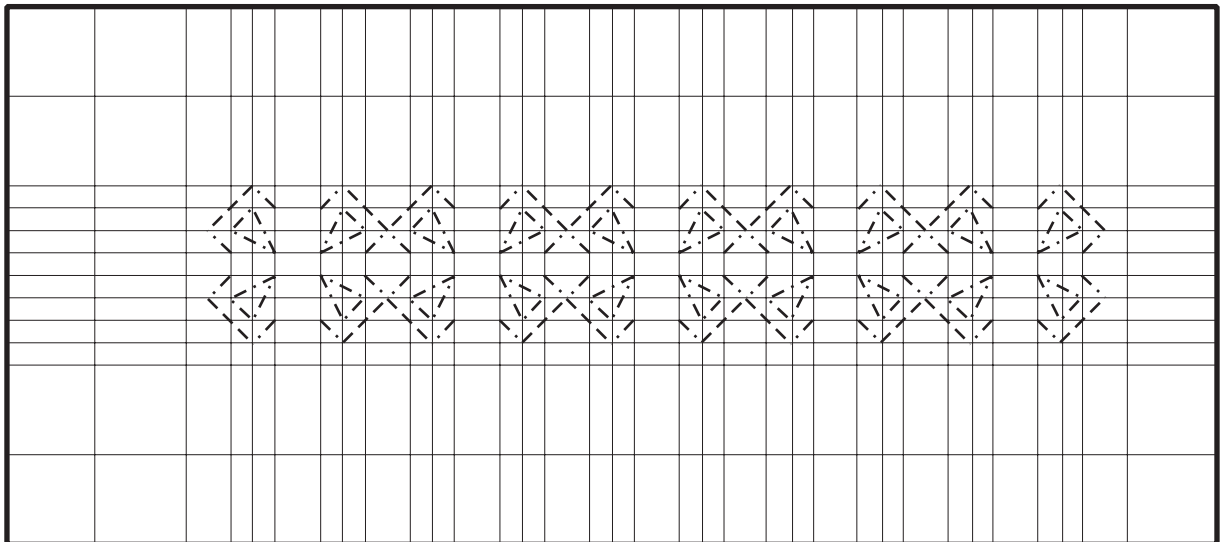

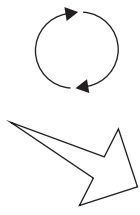

21

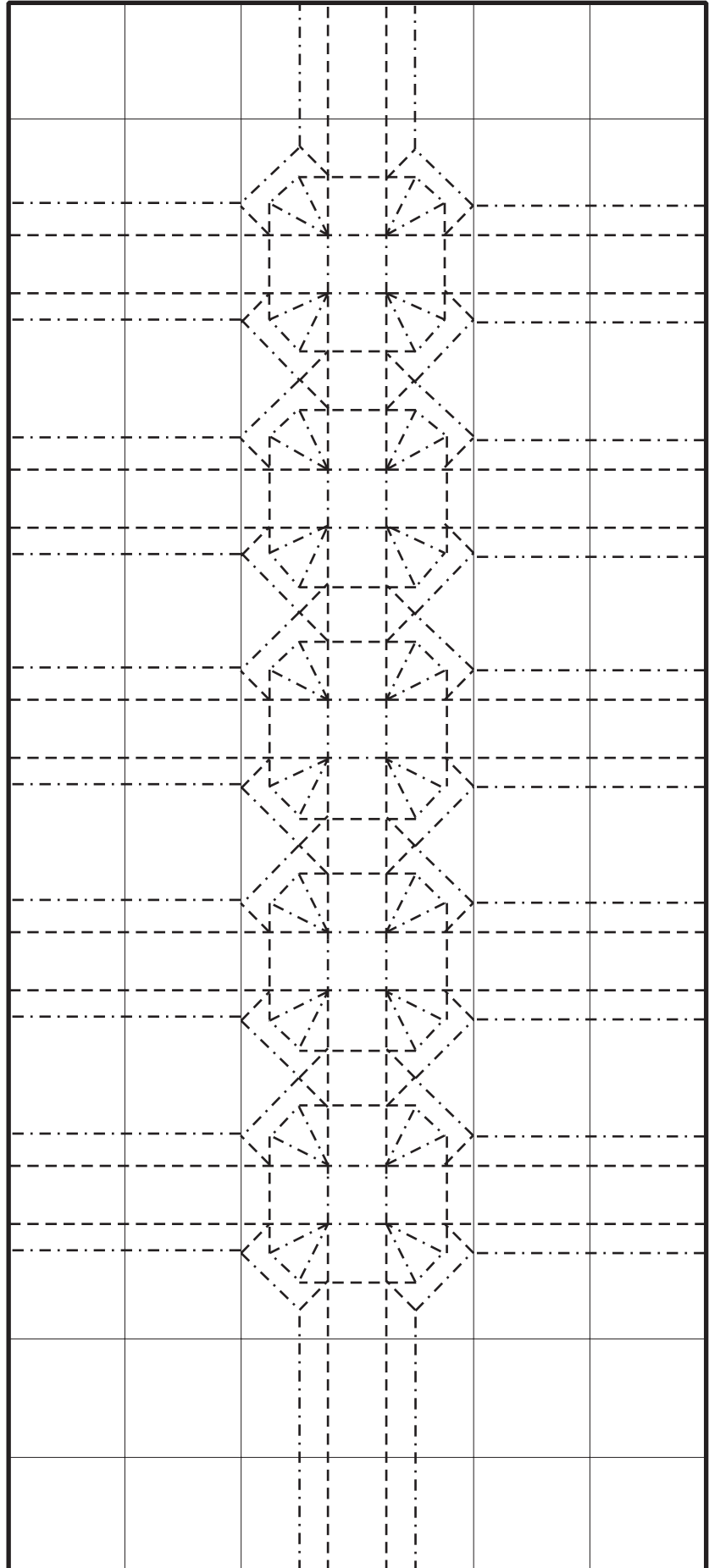

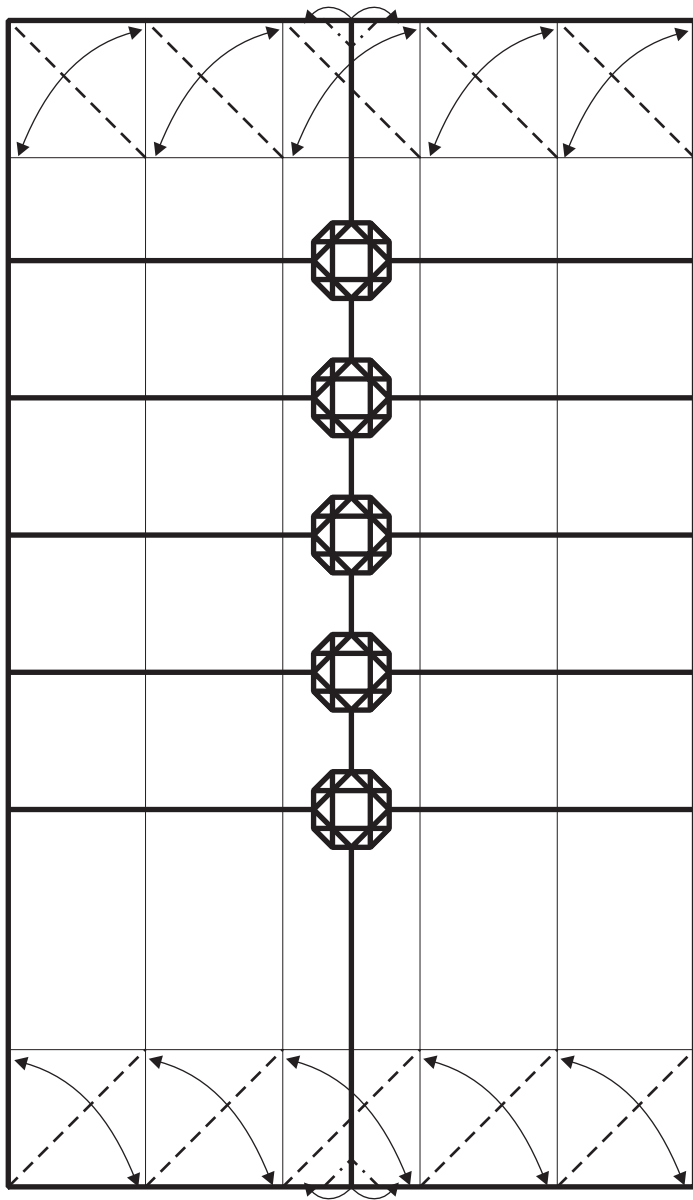

22

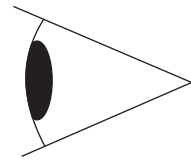

23

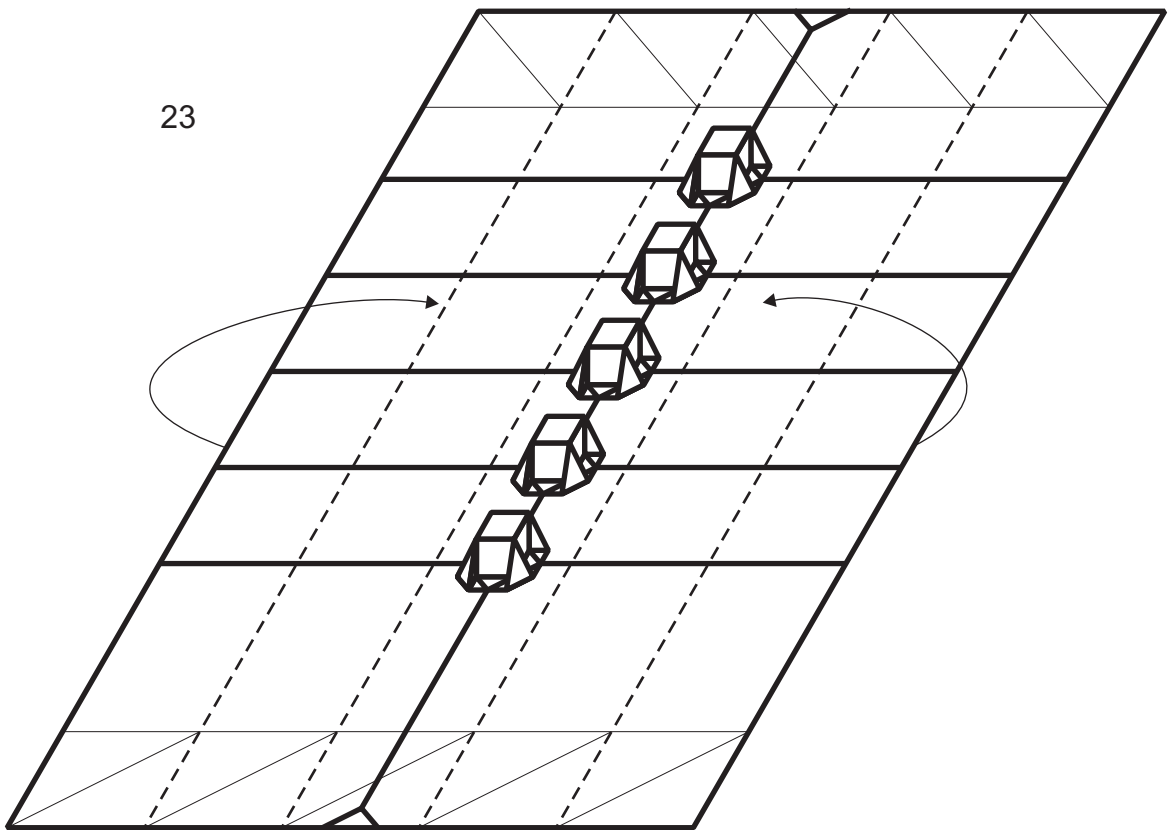

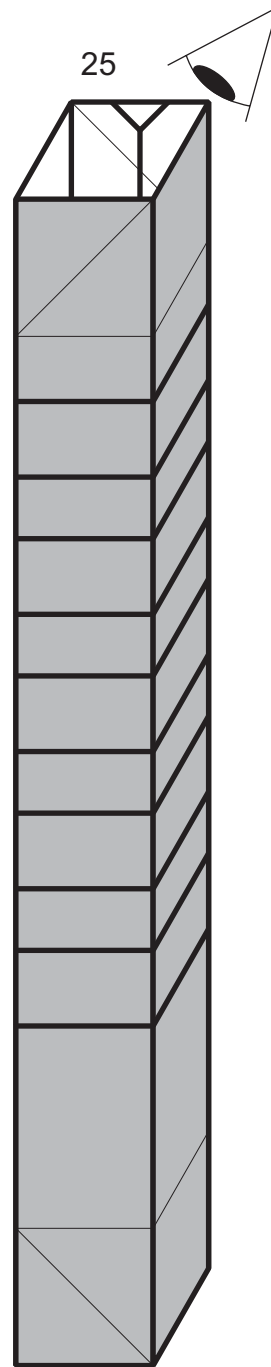
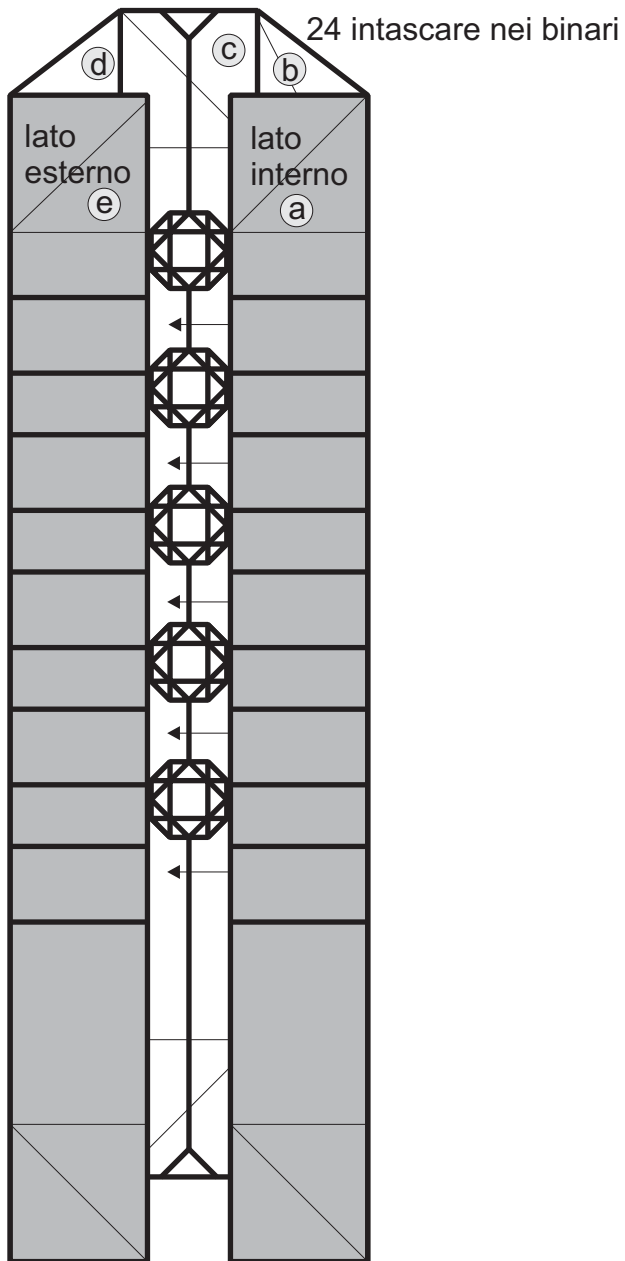

26 disegno semplificato e con i lati superiori trasparenti

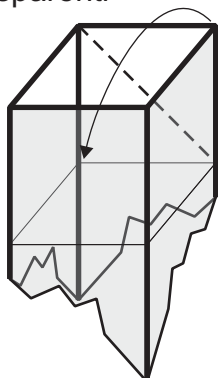

27

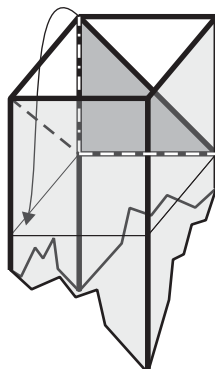

28

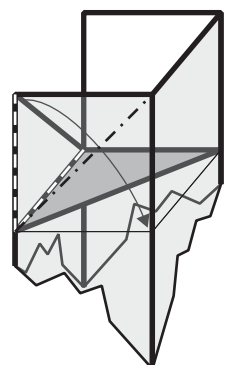

29

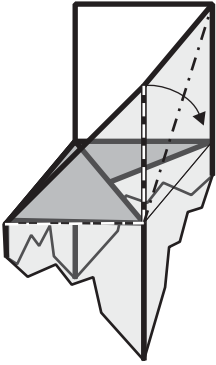

30

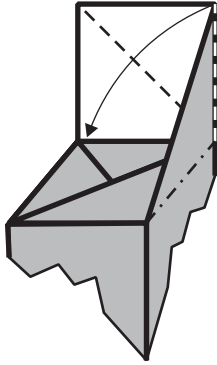

31

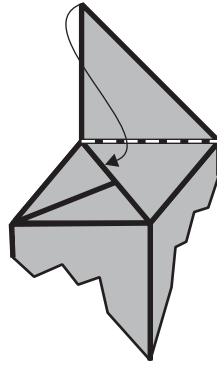

32

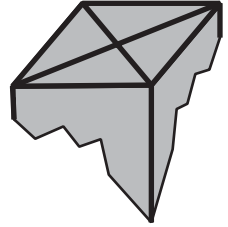

33

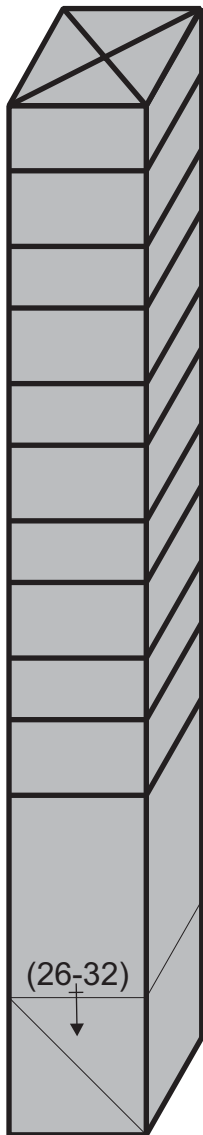

34

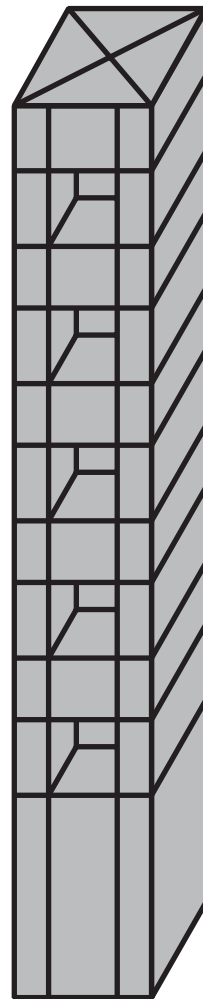

X2

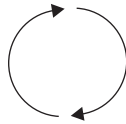

(26-32)

asticella

iniziare con un rettangolo 5X14.

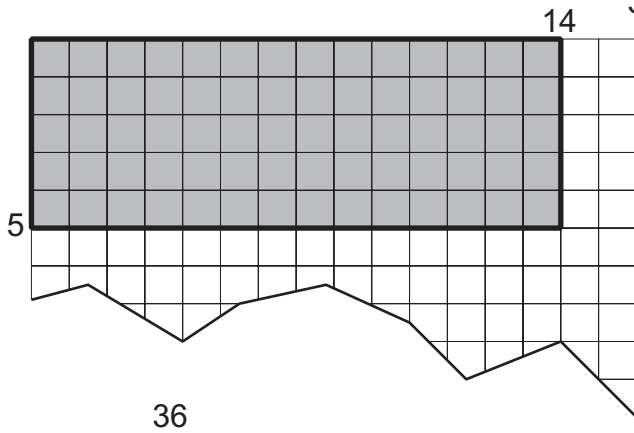

35 dividere in quinti segnando solo i bordi

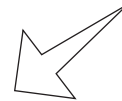

36



37 piegare e riaprire

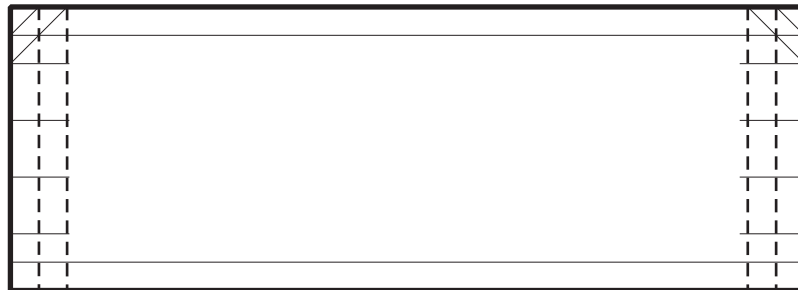

38 arrotolare
come una
sigaretta
aiutandosi
con una
matita

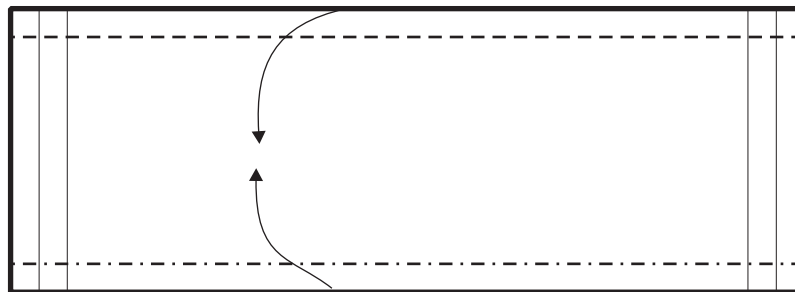

39





rondella

iniziare con un rettangolo 1,5X5,5.

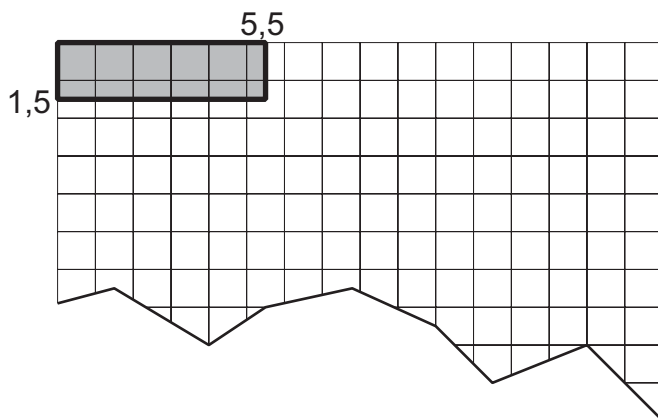

43

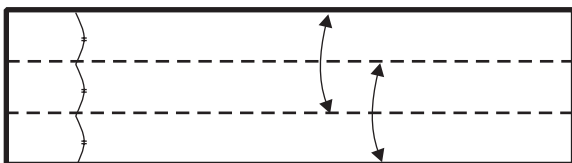

44

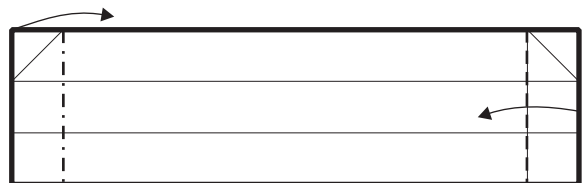

45 arrotolare come una sigaretta
aiutandosi con una matita

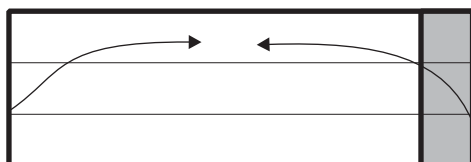

46

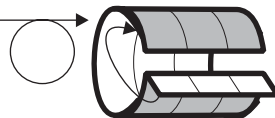

47



48



49

Assemblaggio

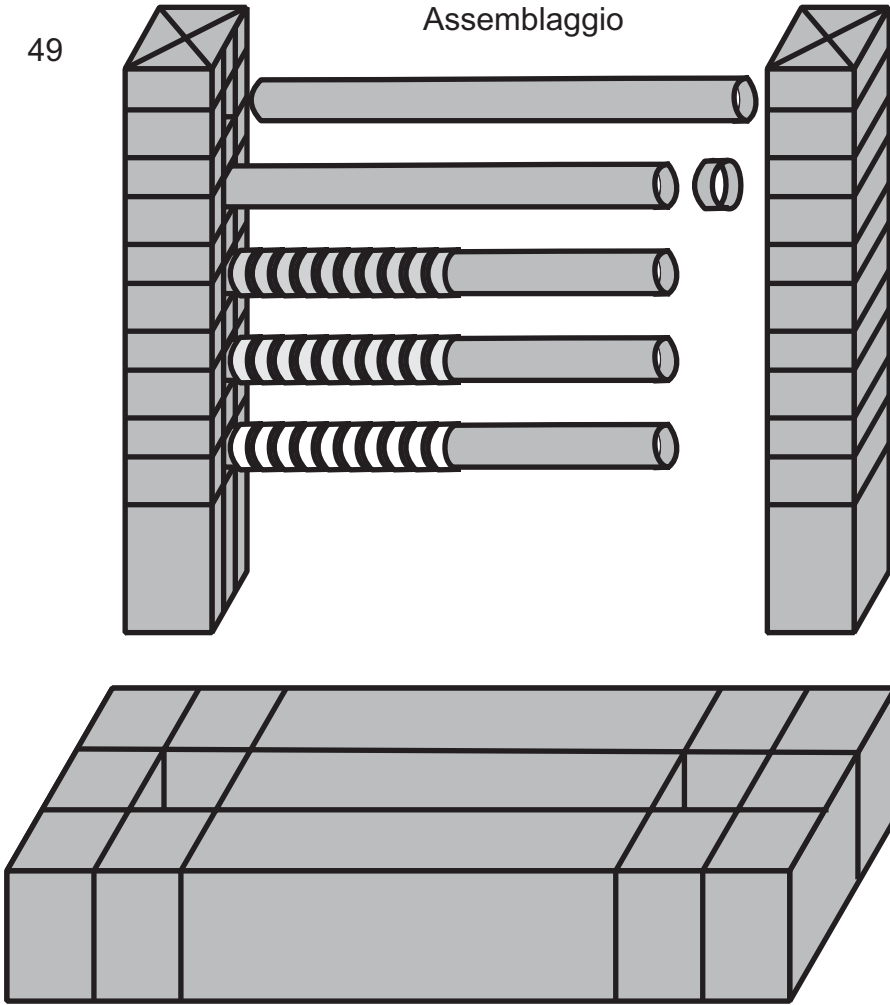

sai cosa ha detto il
dottore all'abaco?

avete i calcoli!!!



50

