

Pinguino



ORIGAMI
PASQUALE D'AURIA

origamidauria.it



[origamidauria](https://www.facebook.com/origamidauria)

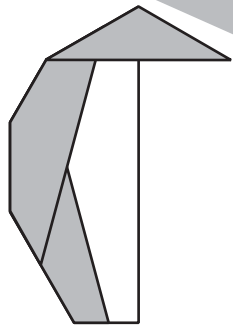

1

2

3

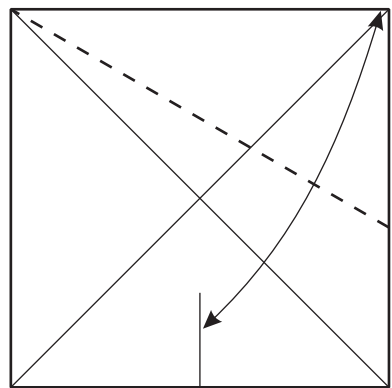
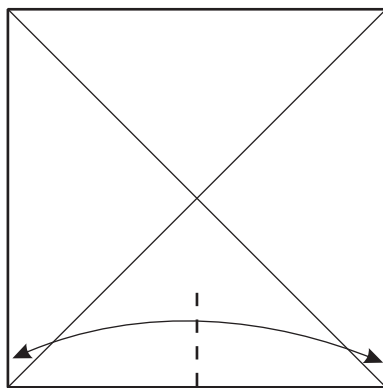
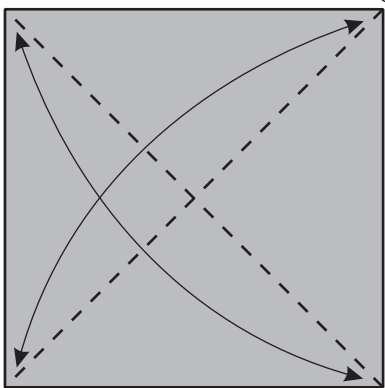

4

5

6

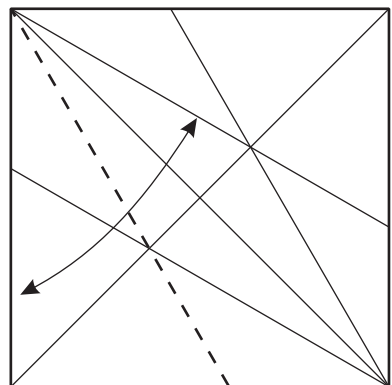
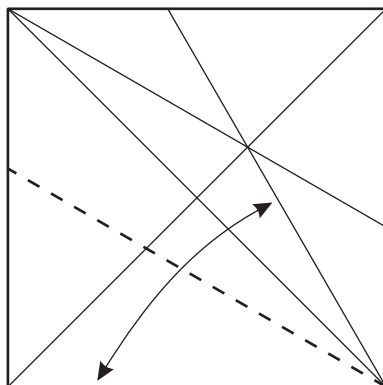
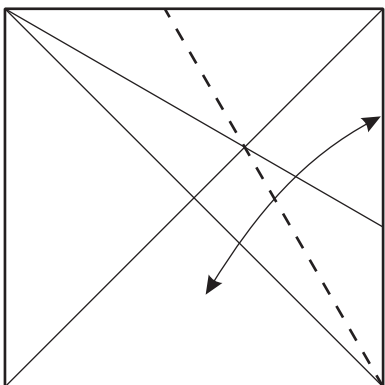

1



7

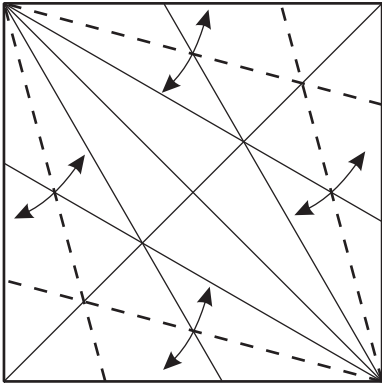

8

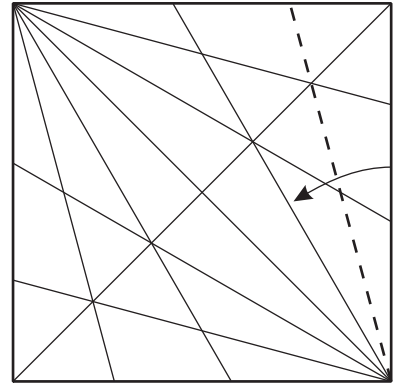

9

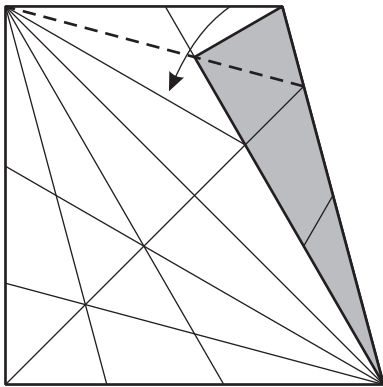

10

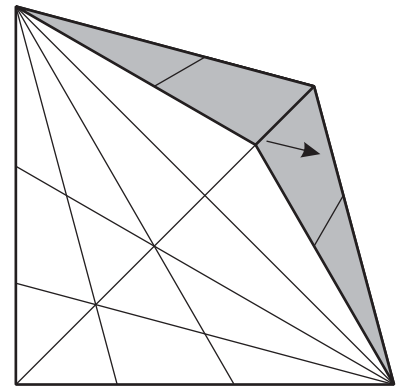

11

ripetete i passi da 8 a 10 sull'altro lato

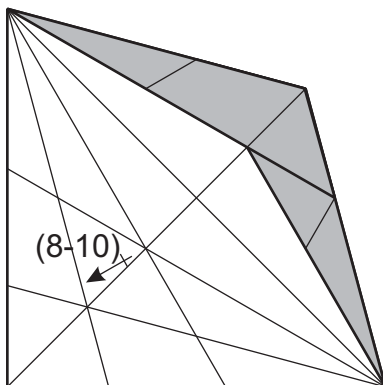

12

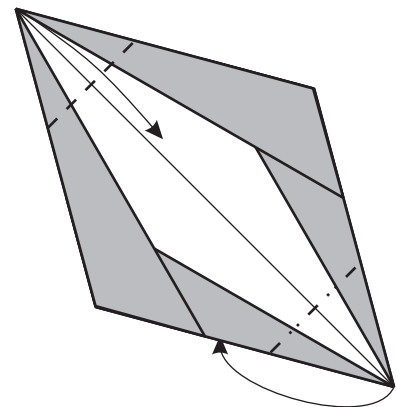

2



13 con piega a monte portate indietro un lato

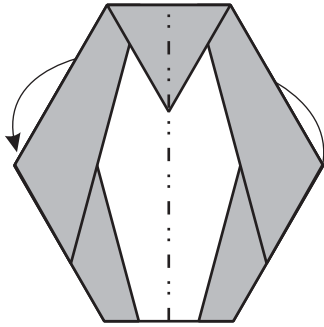

14 tirate la punta facendo ruotare la parte superiore del modello

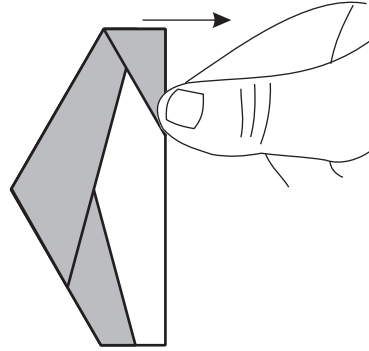

15 schiacciate sui lati

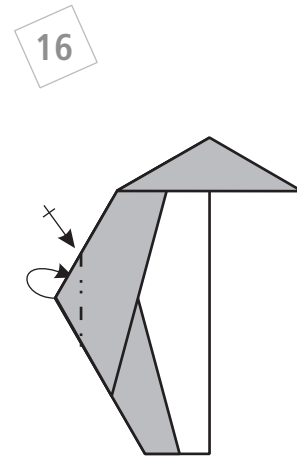
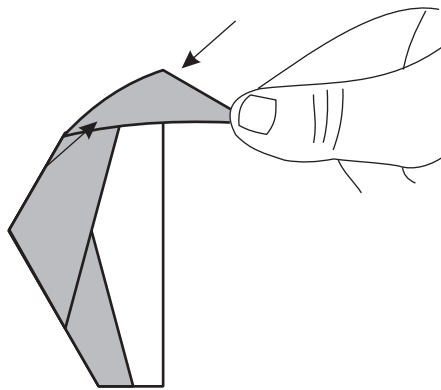

il colmo per un pinguino?

odiare le freddure!

17

