

# Formico di P. D'Auria

<http://www.origamidauria.it>

iniziare con un quadrato, preferibilmente carta metallizzata, cercando la giusta grandezza per creare una formica più piccola possibile, ma avere la possibilità di modellarla con precisione, per iniziare consiglio un lato di 35 cm

1

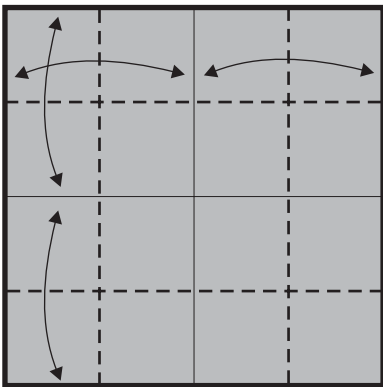

2

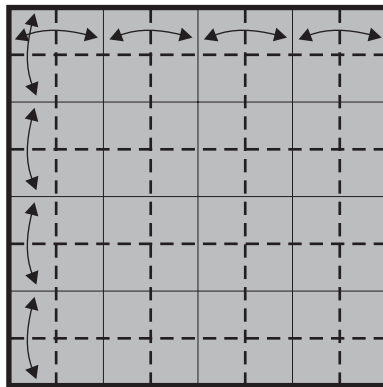

3

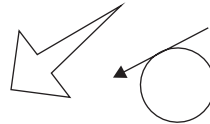
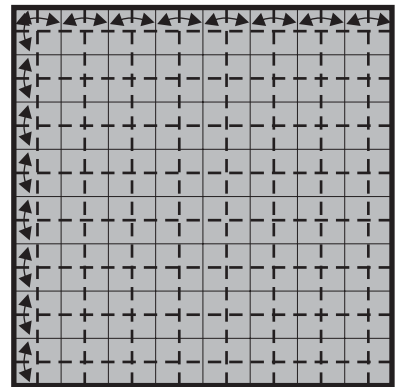

4

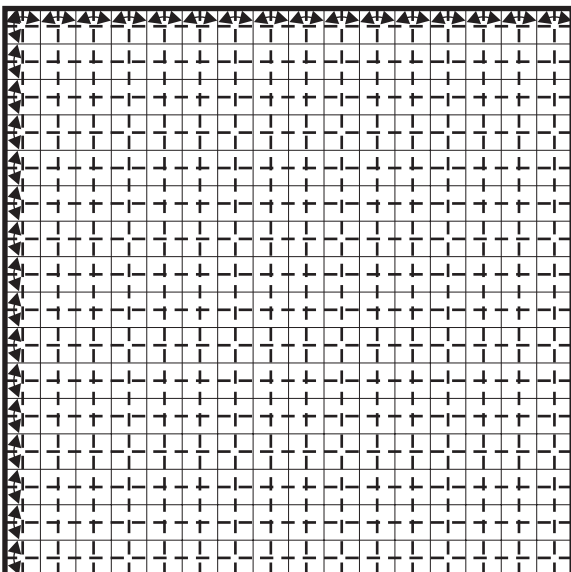

5

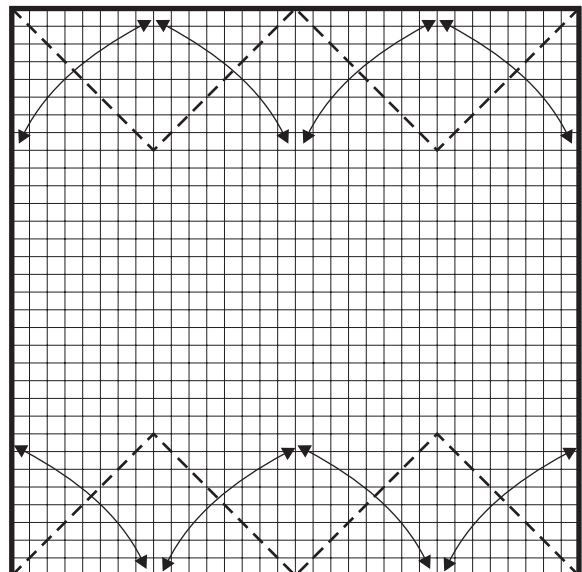

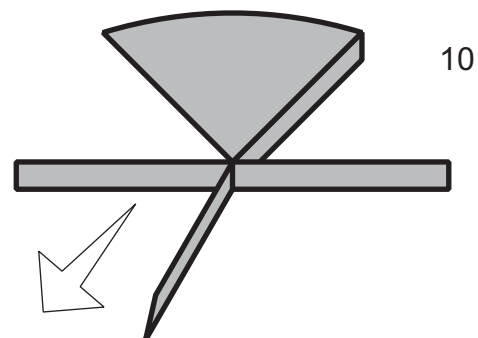
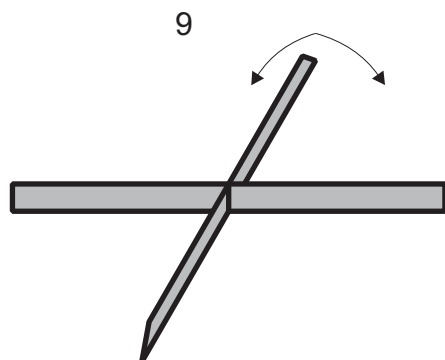
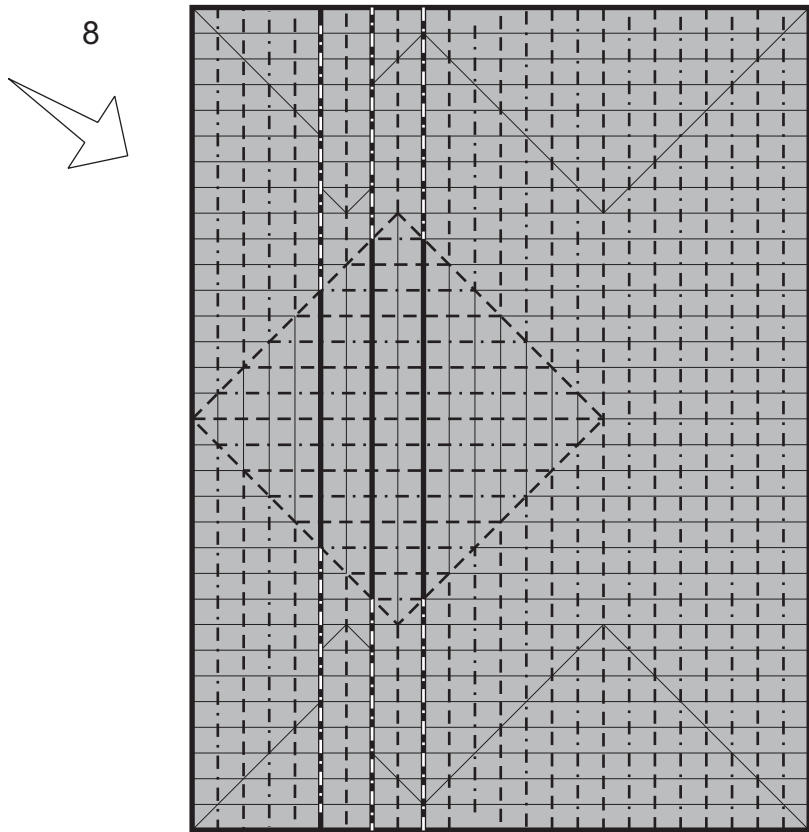
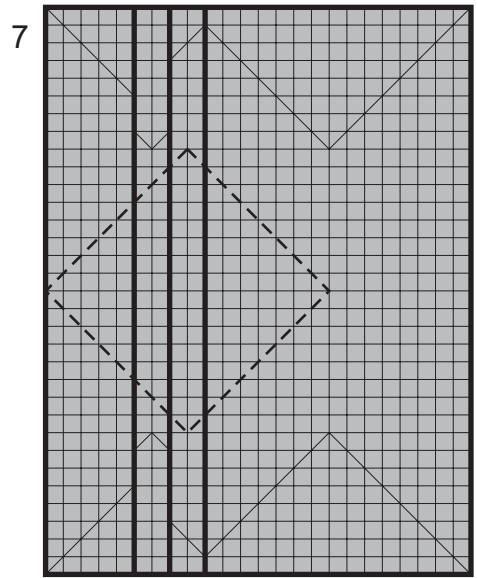
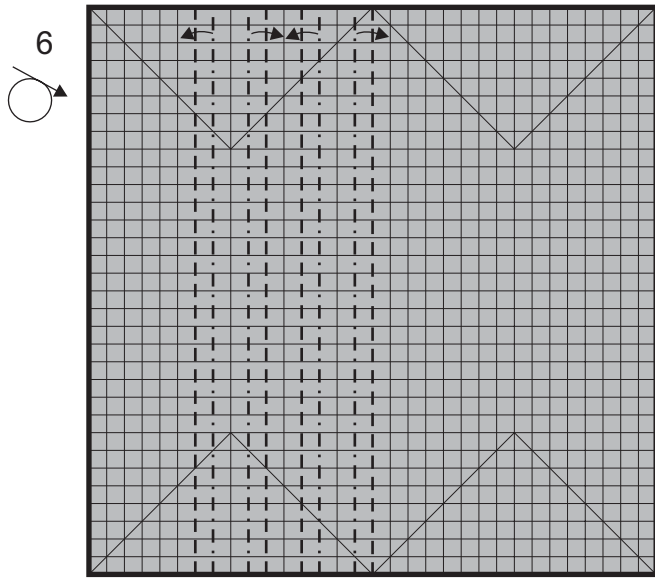

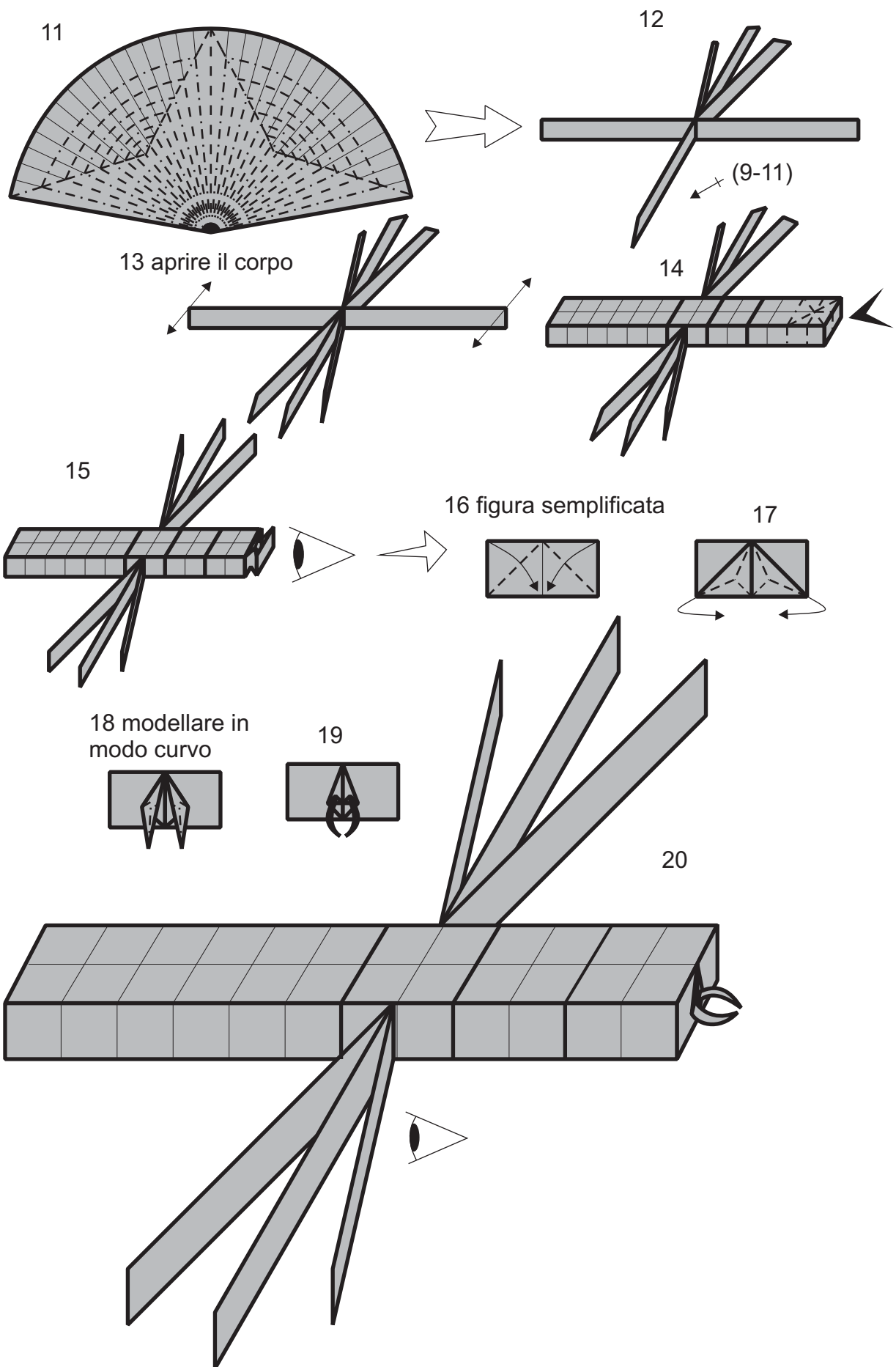

21 vista  
semplificata



22

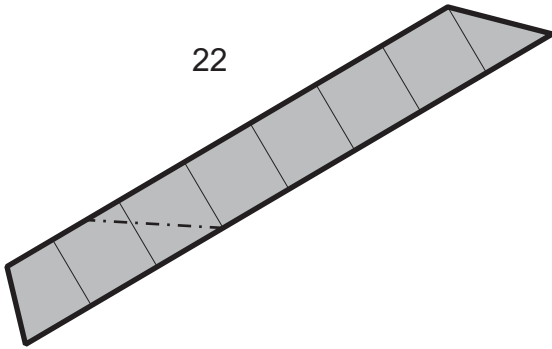

23

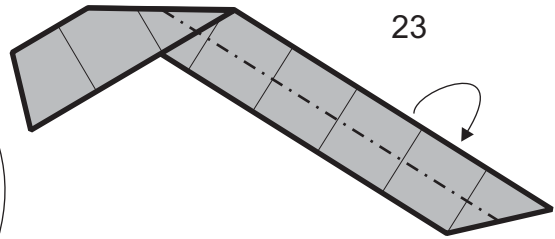

24

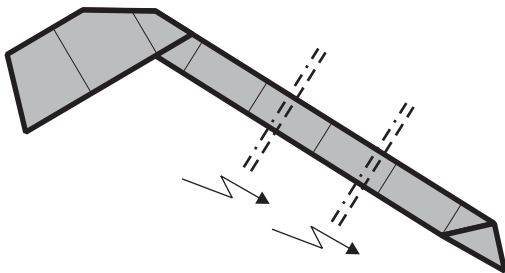

25

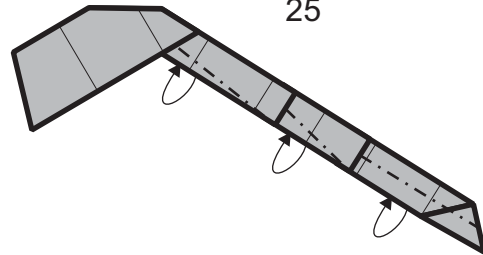

26 modellare  
ancora

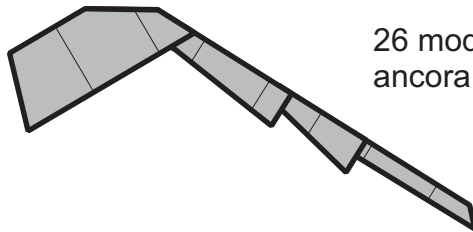

(21-26) 27

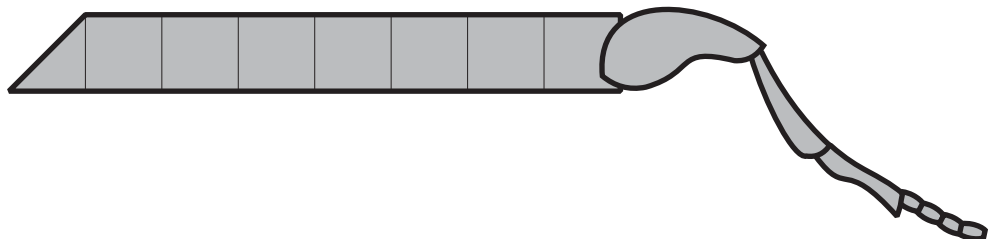

28 un ulteriore miglioramento  
è piegare la zampa posteriore  
leggermente differente dalle  
due anteriori

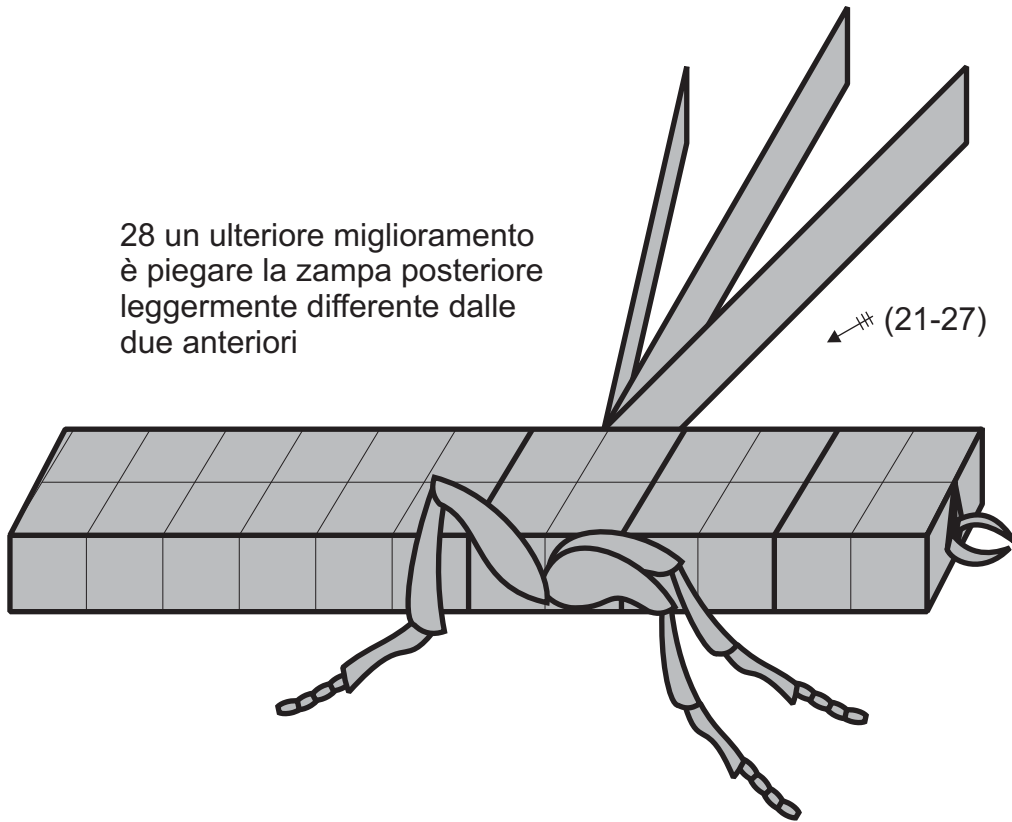

29

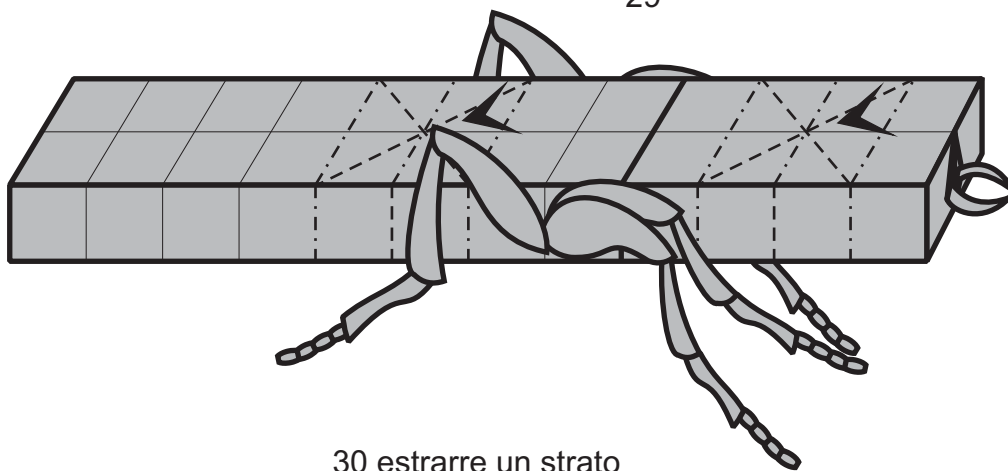

30 estrarre un strato

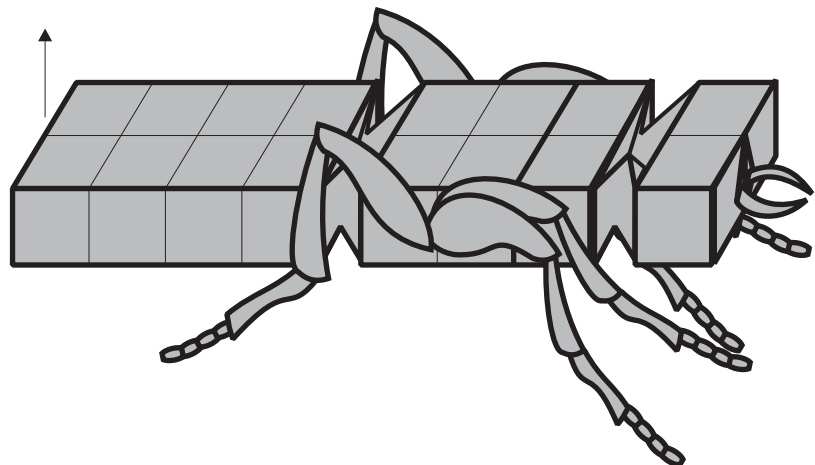

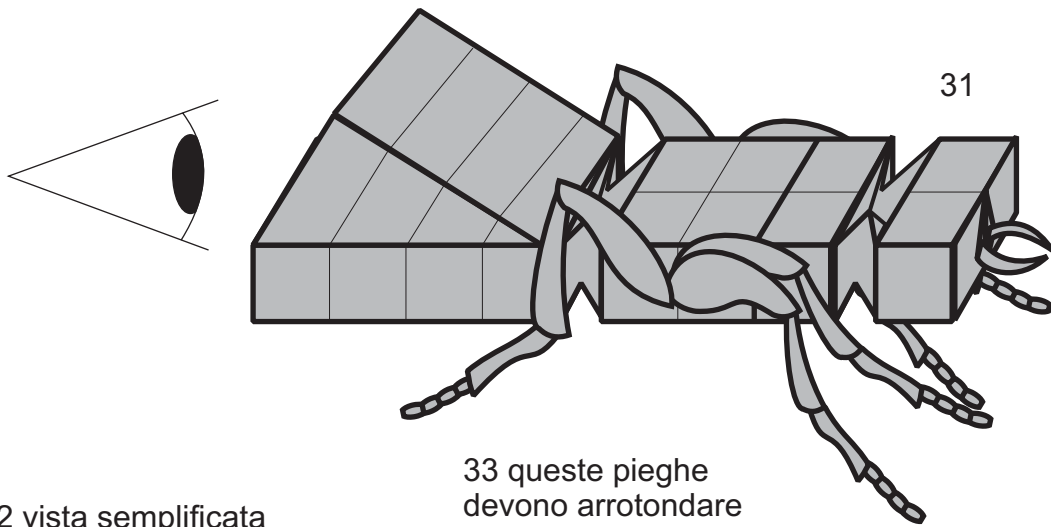

31

32 vista semplificata

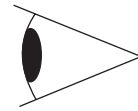
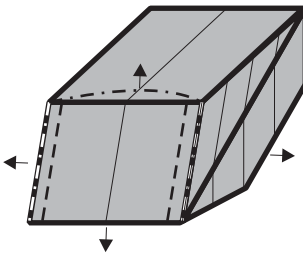
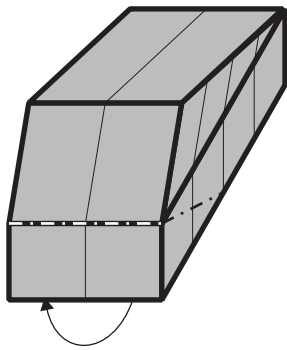

33 queste pieghe devono arrotondare l'addome, poi modellare fino ad ottenere la figura ..

34 assottigliare la parte posteriore del torace

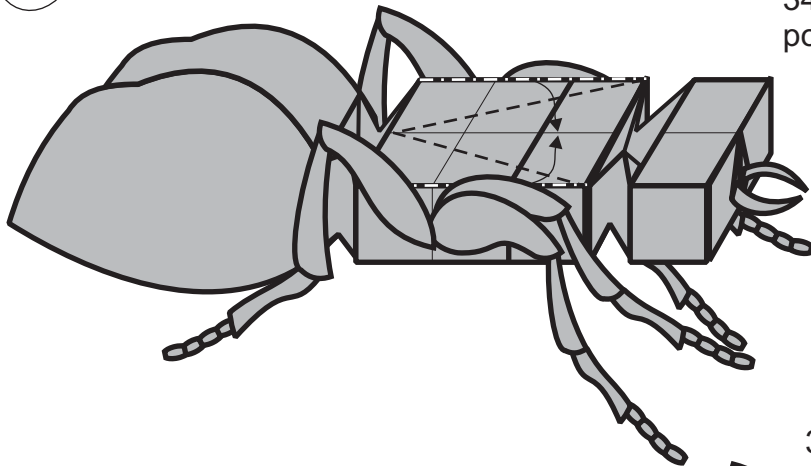

35 modellare il torace

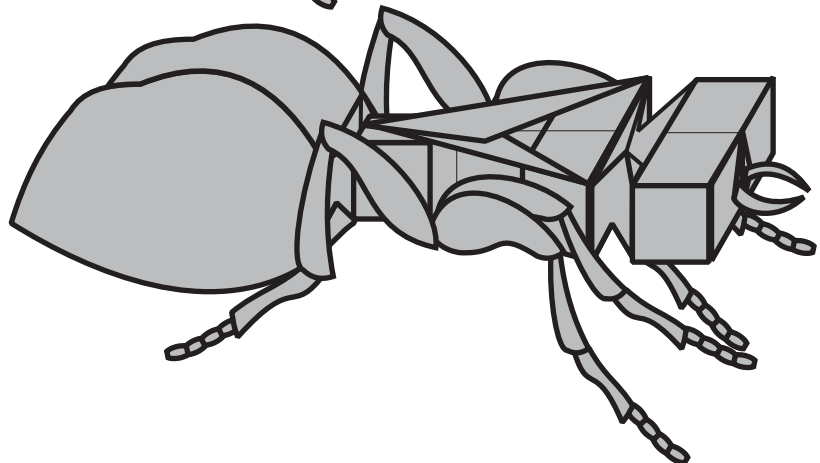

36 modellare la testa

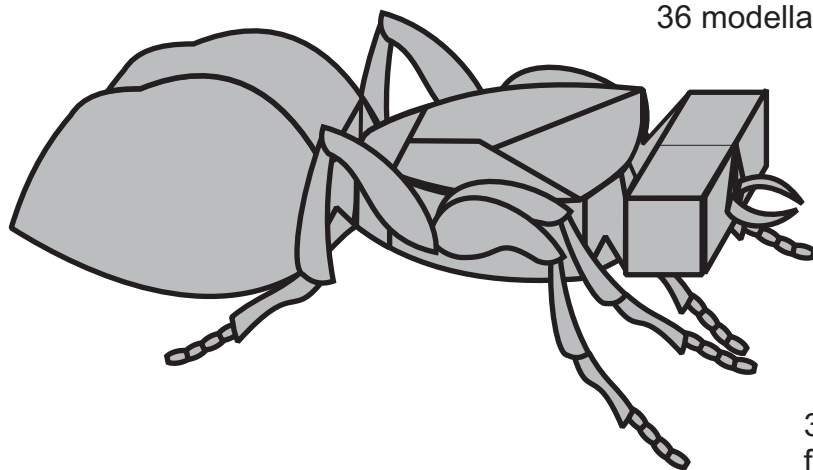

37 creare gli occhi, per farlo si può usare l'astuccio di una biro senza pennino

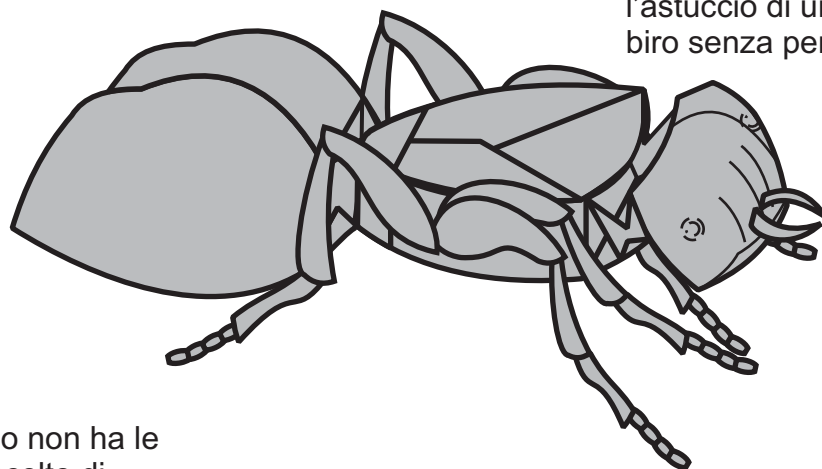

38 questo modello non ha le antenne, ma ho scelto di non appesantire la struttura con altri strati, preferendo un particolare in meno, ma un origami più elegante.

