

# Stella marina (Anseropoda placenta) di P. D'Auria

<http://digilander.libero.it/origamidauria>

1

2

3

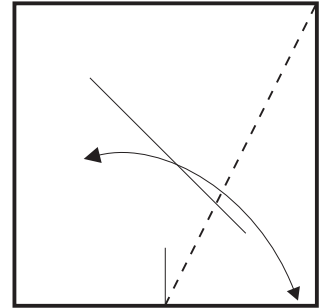
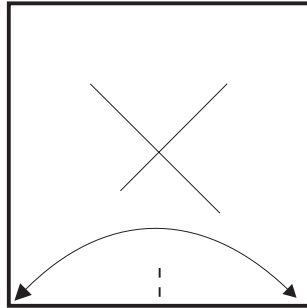
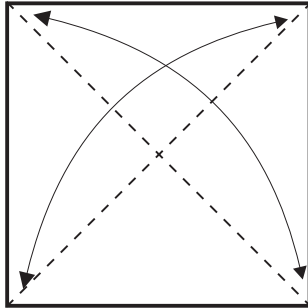

4

5

6

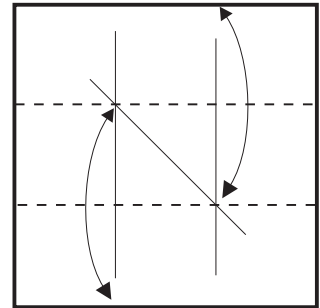
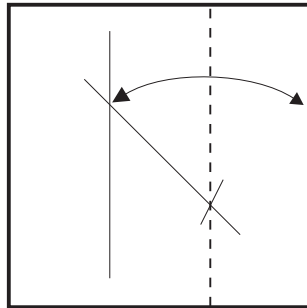
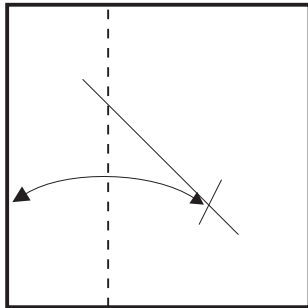

7

8

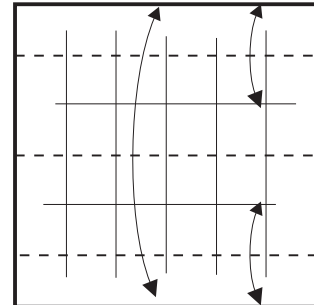
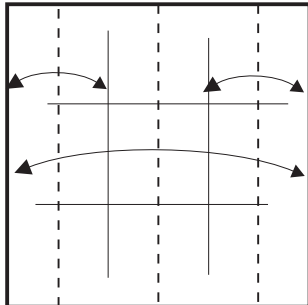

9

10

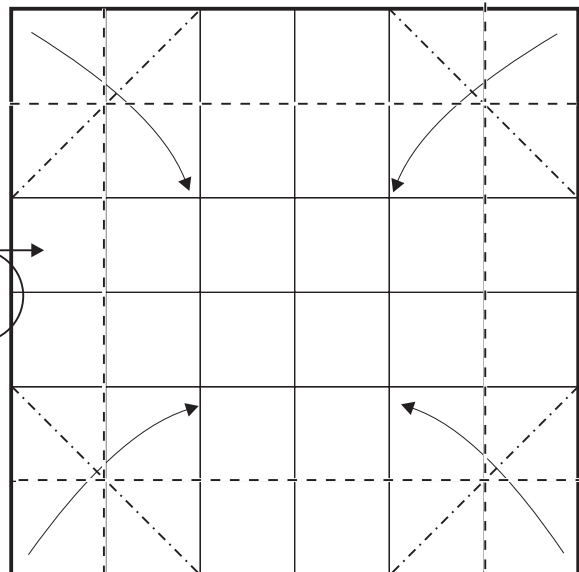
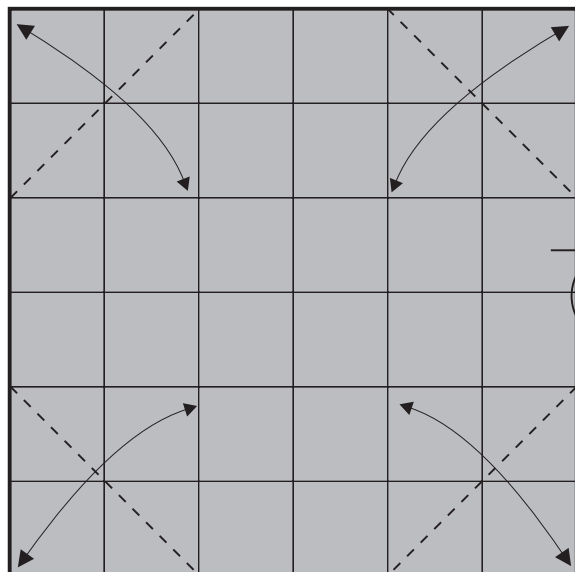
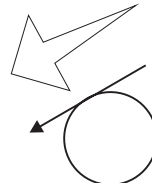

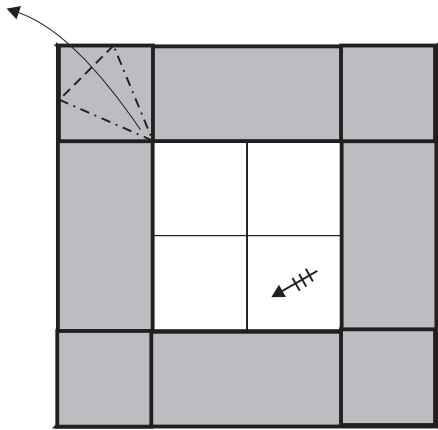

11

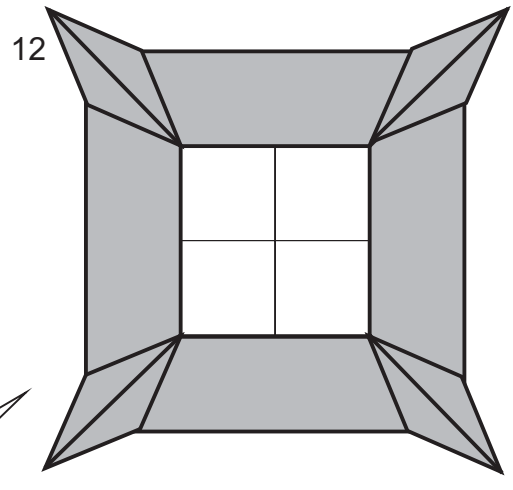

12

13

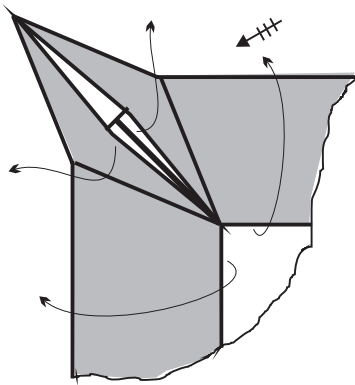

14

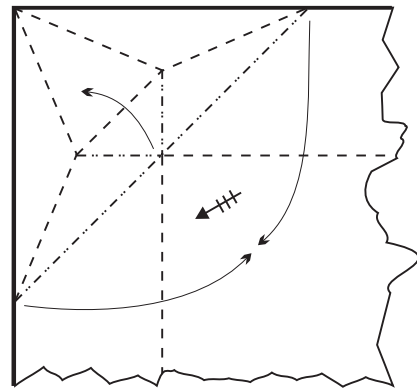

15

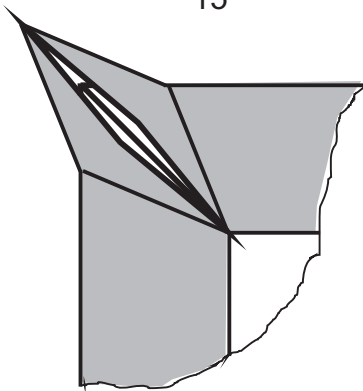

16

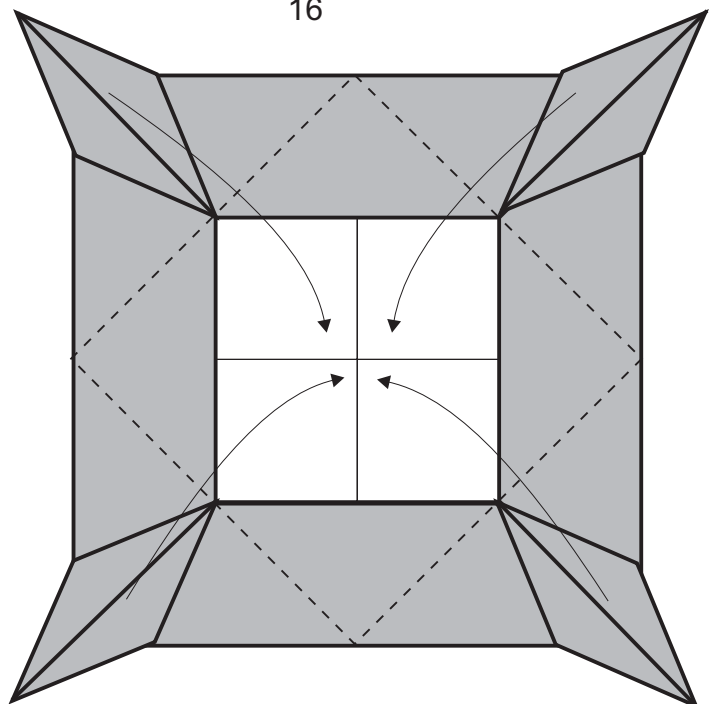

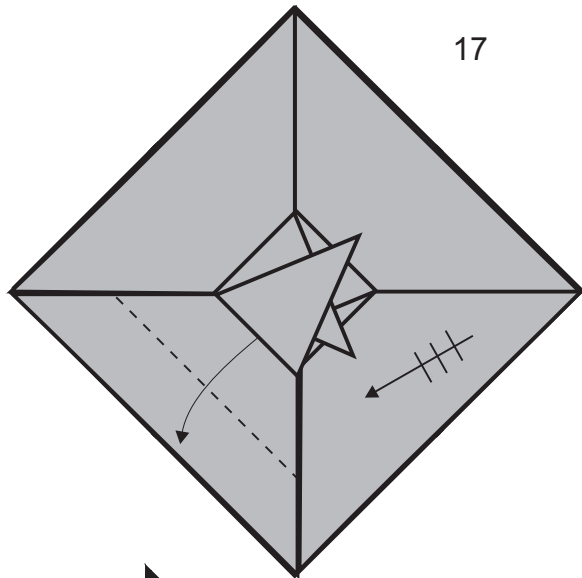

17

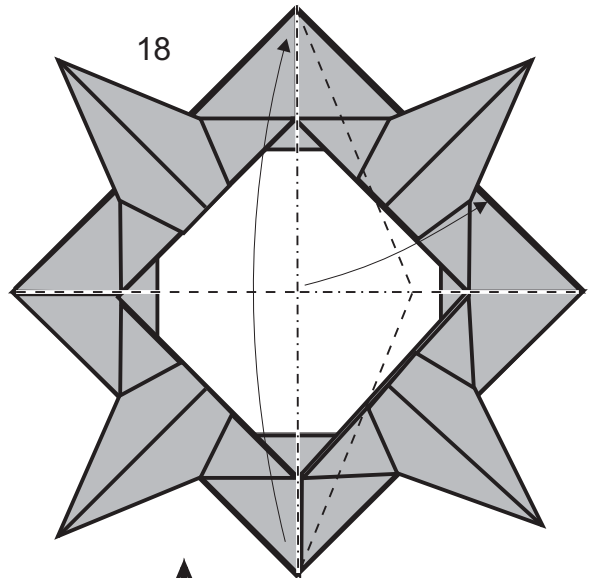

18

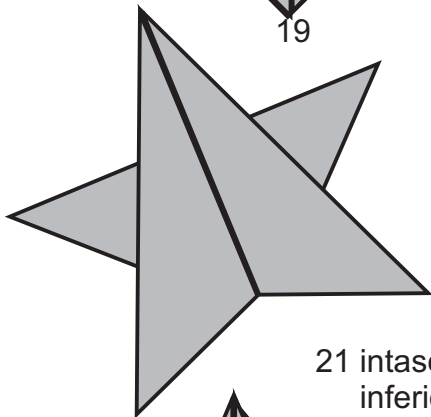

19

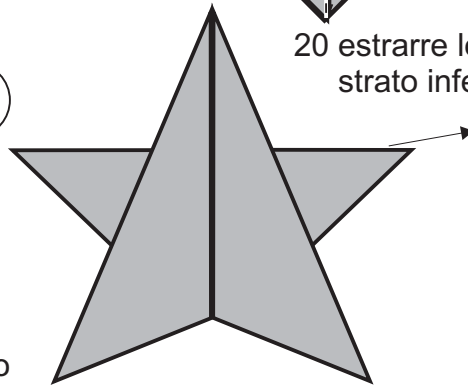

20 estrarre lo strato inferiore

21 intascare lo strato inferiore in quello superiore e bloccare il modello

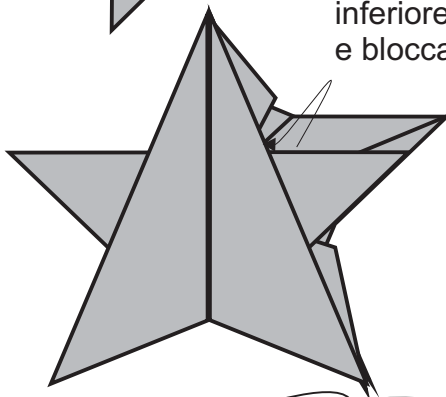

22

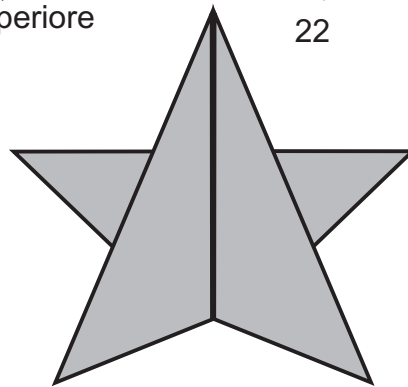

conosci la differenza tra una stella di carta e una banconota?  
allora possiamo fare cambio!!!

no.

