

Rugby

di P. D'Auria

<http://www.origamidauria.it>

iniziare con un rettangolo 1X6
usare carta metallizzata

1

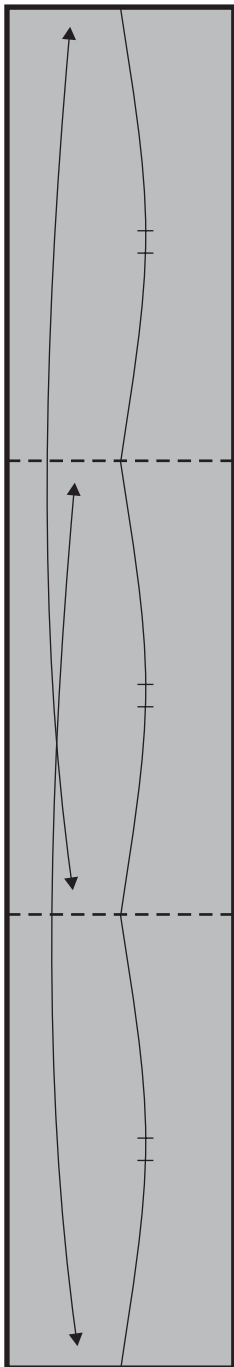

2

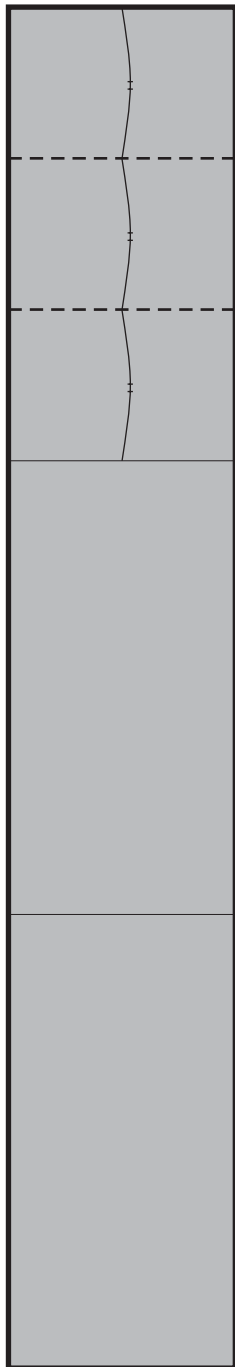

3

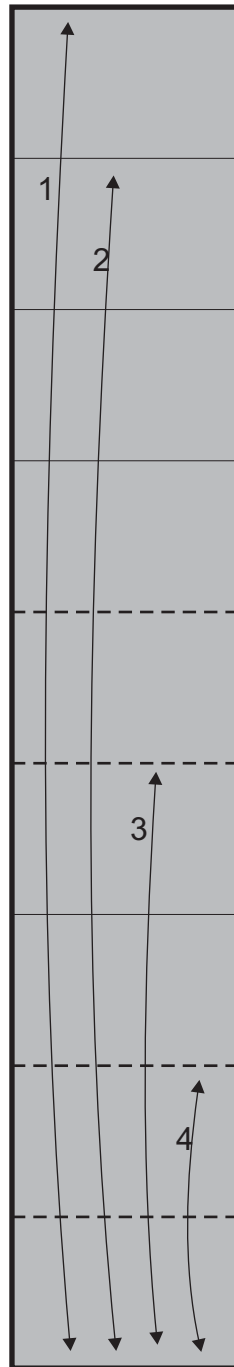

4

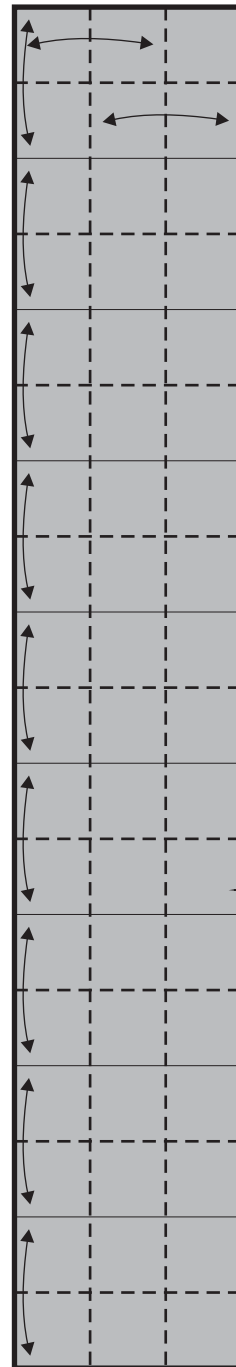

5

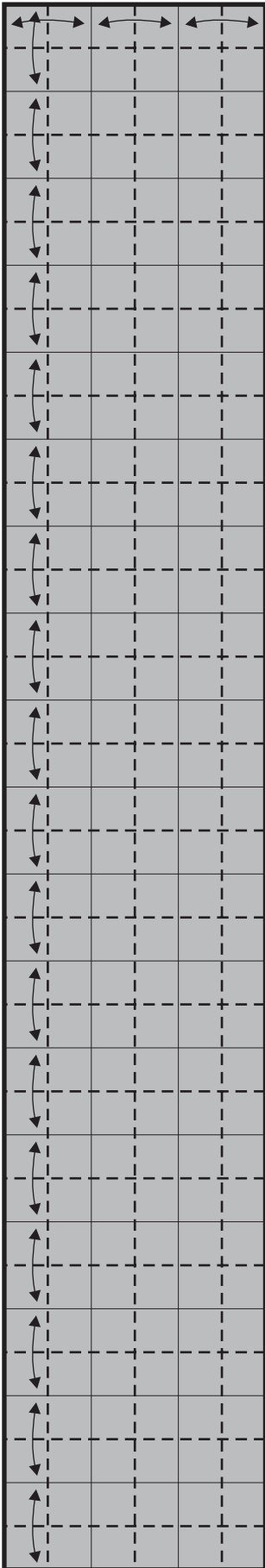

6 abbiamo diviso il foglio in 12x72

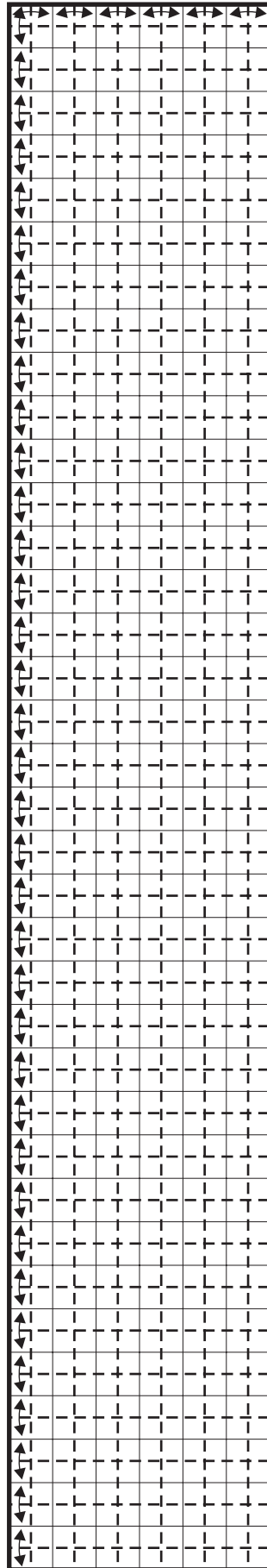
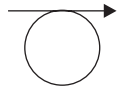

7

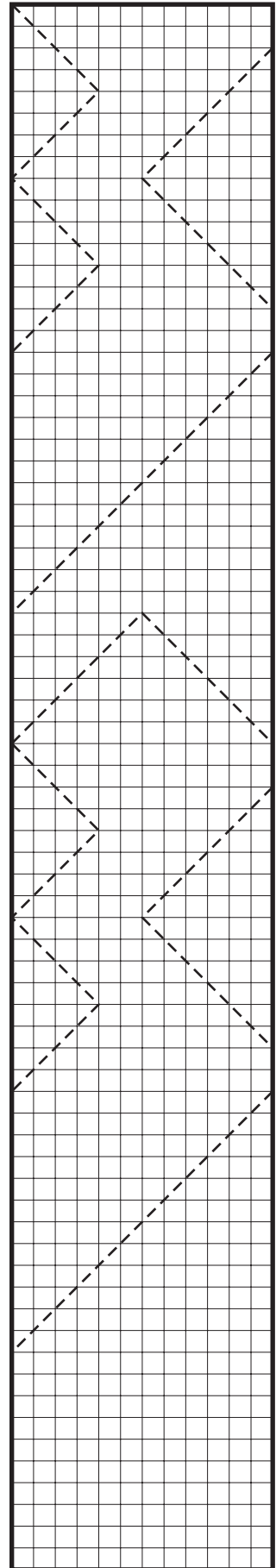

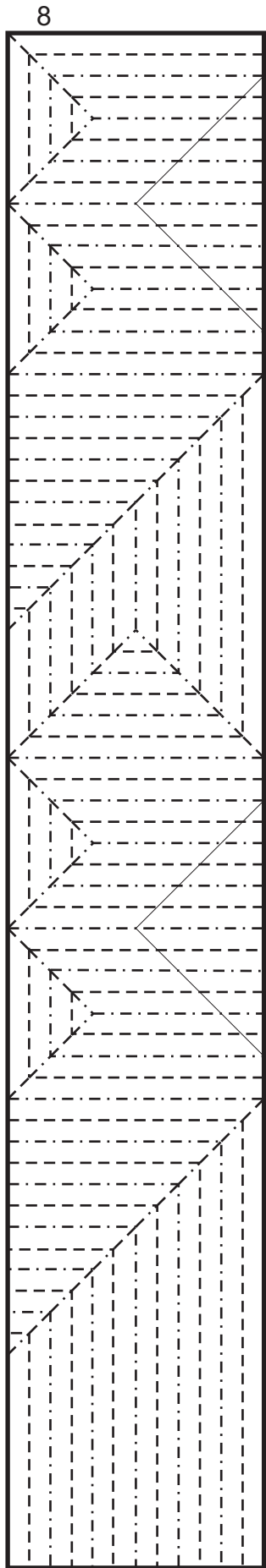

9 aprire quanto basta per dividere le due gambe

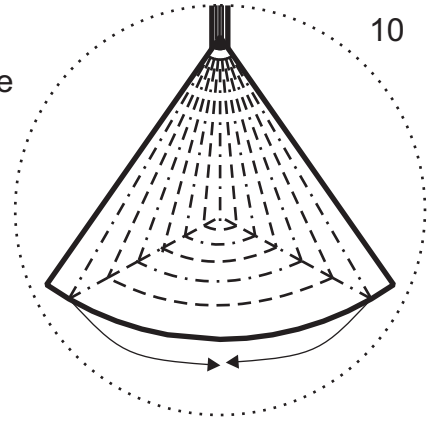
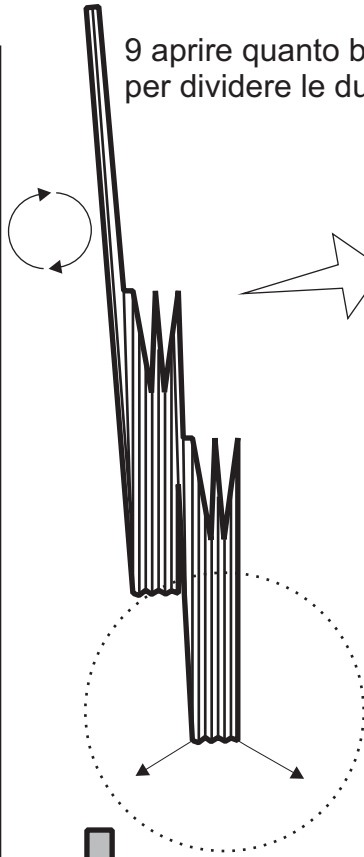

11



12



13

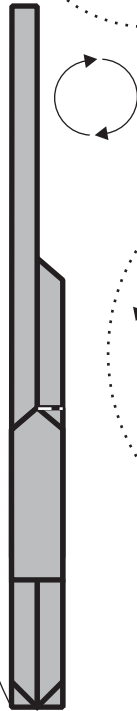

14

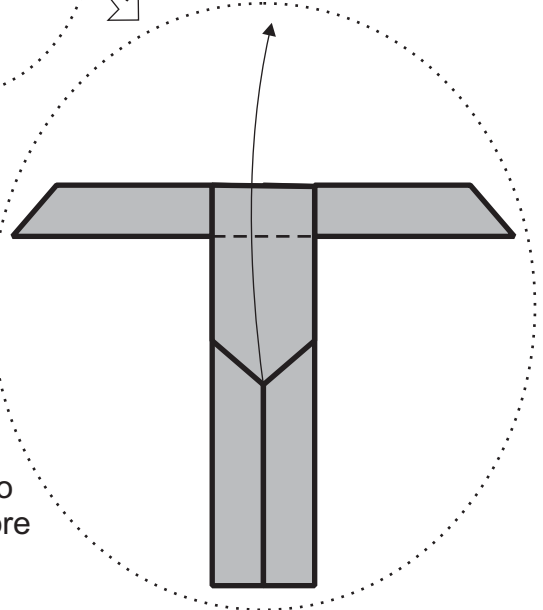
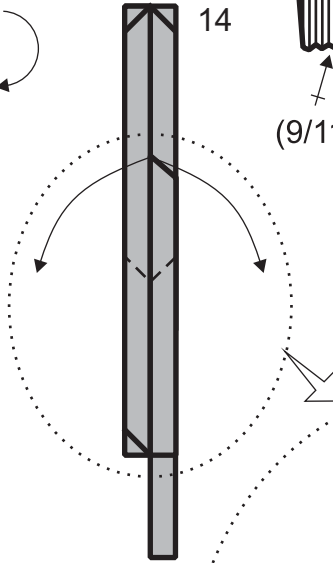

15 disegno semplificato vediamo solo il giocatore in primo piano

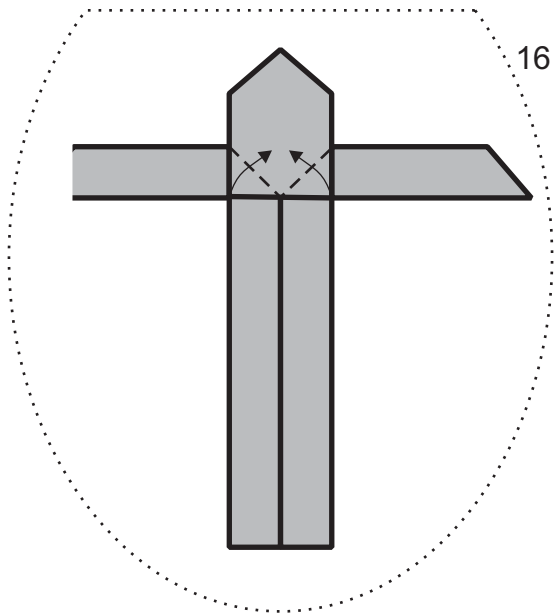

16

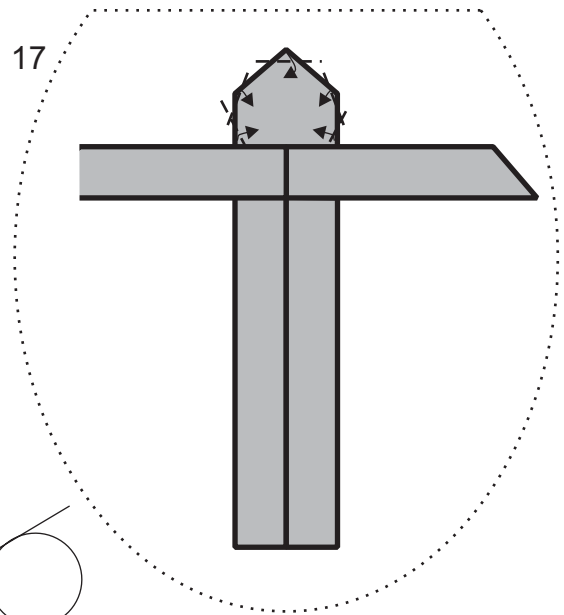

17

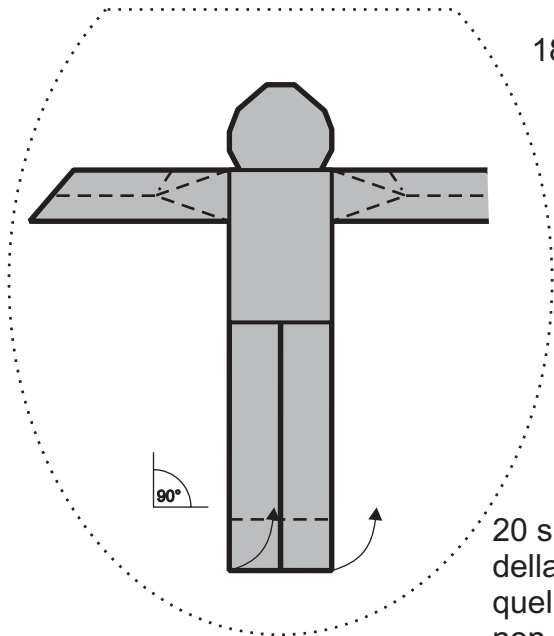
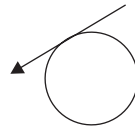

18

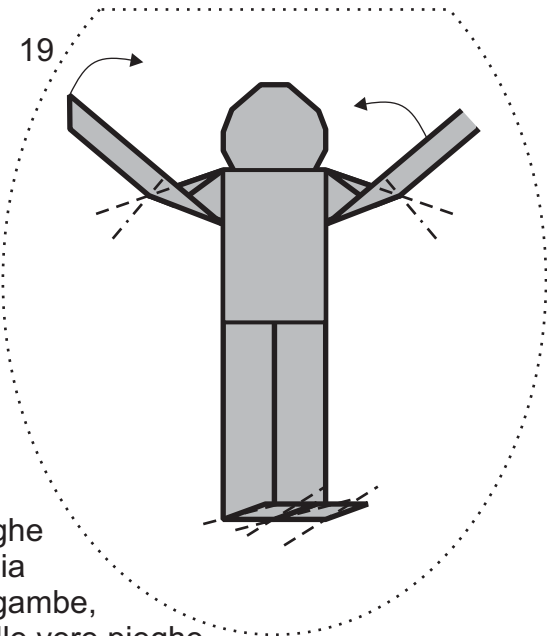

19

20 sia le pieghe della mano sia quelle delle gambe, non sono delle vere pieghe a valle o a monte, ma sono un modellare la carta

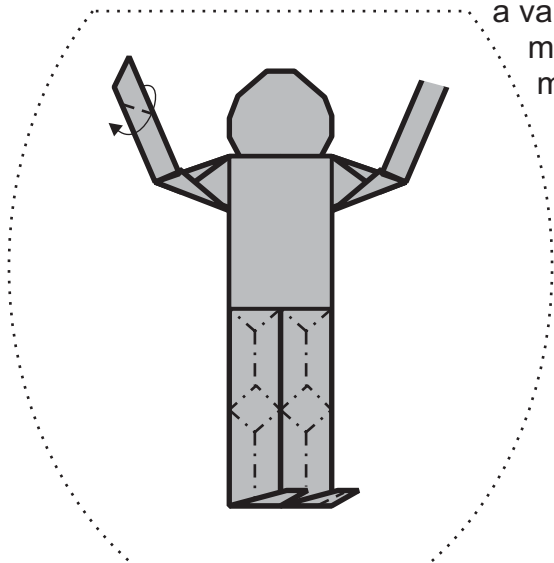

21

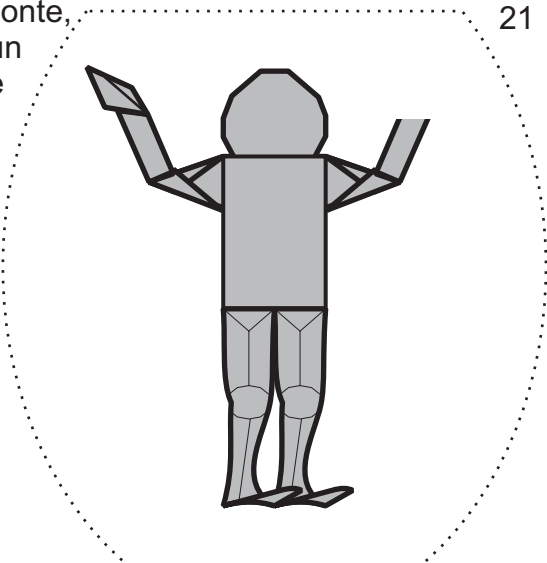

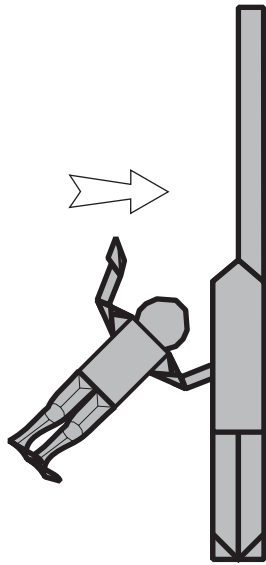

22 con la carta che fuoriesce dal braccio formare il pallone, volendo si può invertire il colore

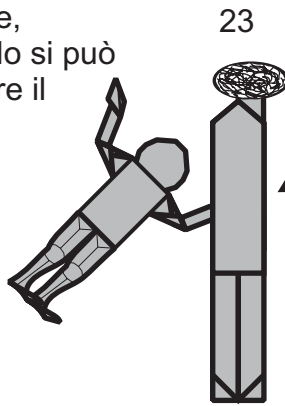

(14/21)

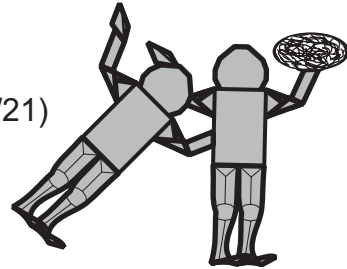

24 modellare i corpi dei due giocatori e soprattutto metterli nella posizione di placcaggio guardando una foto

