

Giraffa

di P. D'Auria

<http://digilander.libero.it/origamidauria>

1

2 solo segnare

3

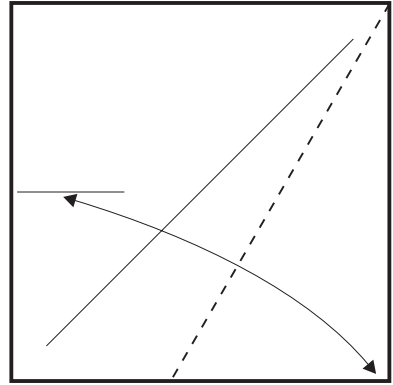
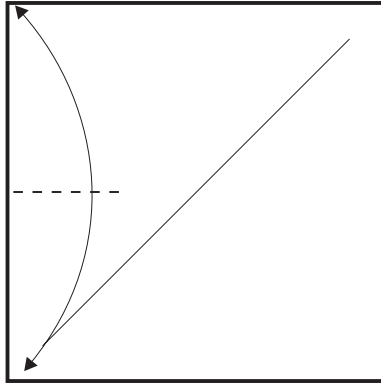
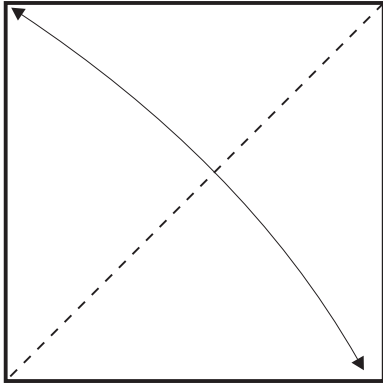

4

5

6 marcare solo dove è segnato

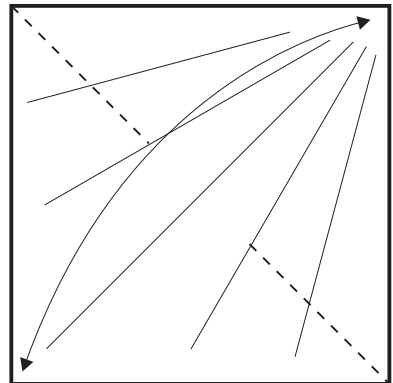
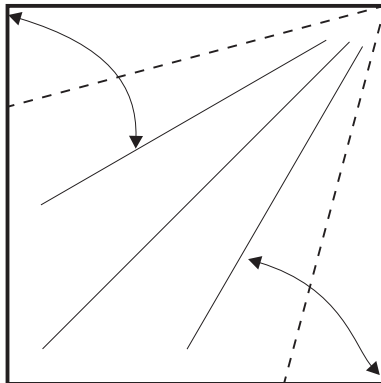
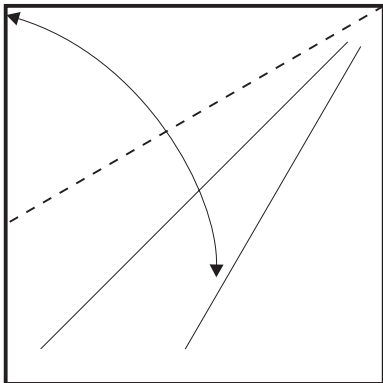

7

8

9

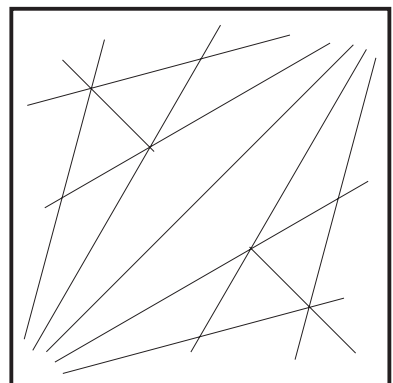
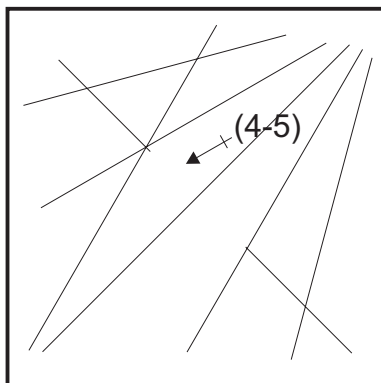
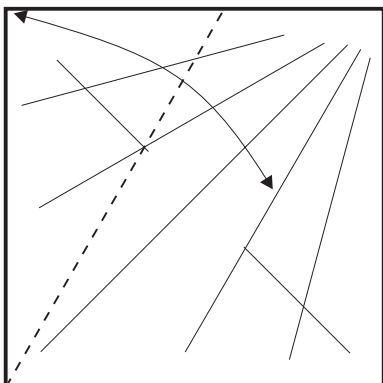

10

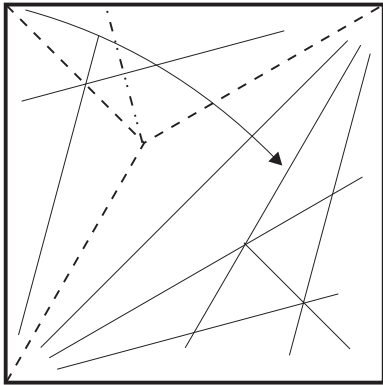

11

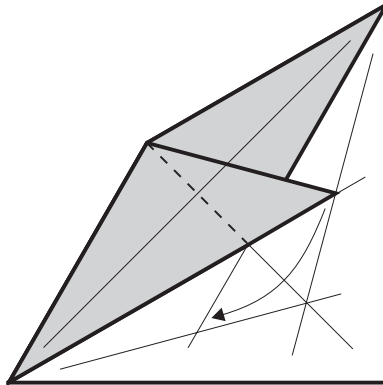

12

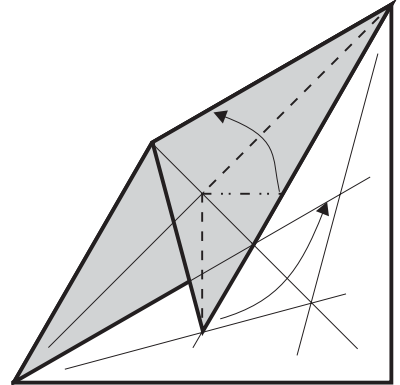

13

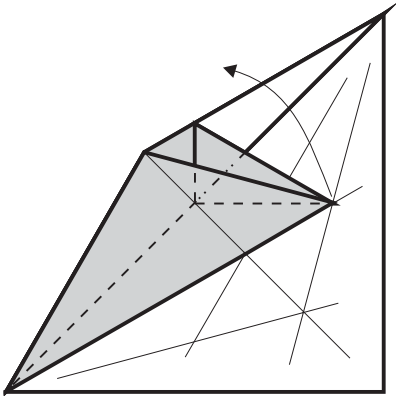

14

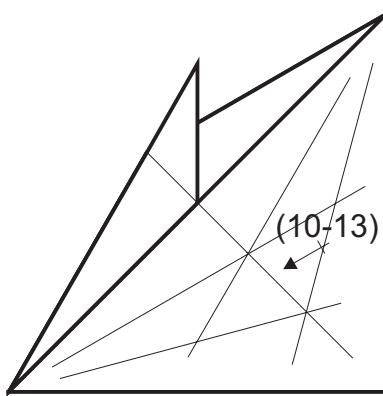

15

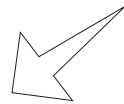
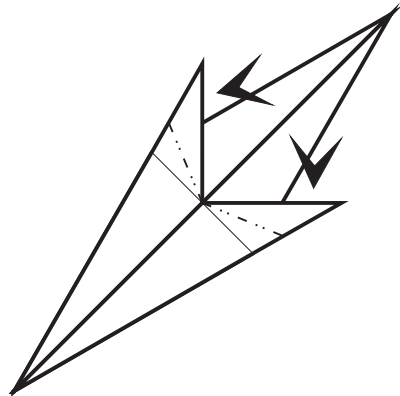

16

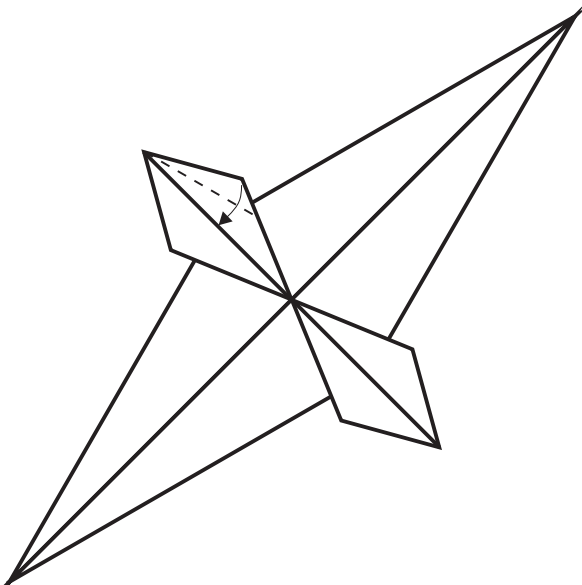

17 intascare

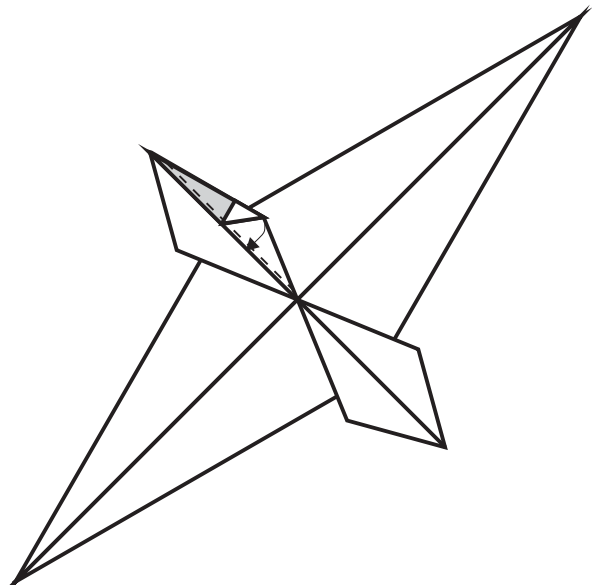

18 estrarre

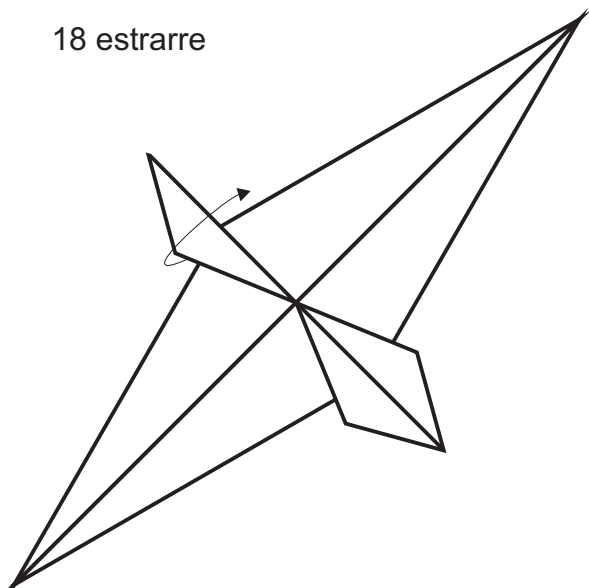

19

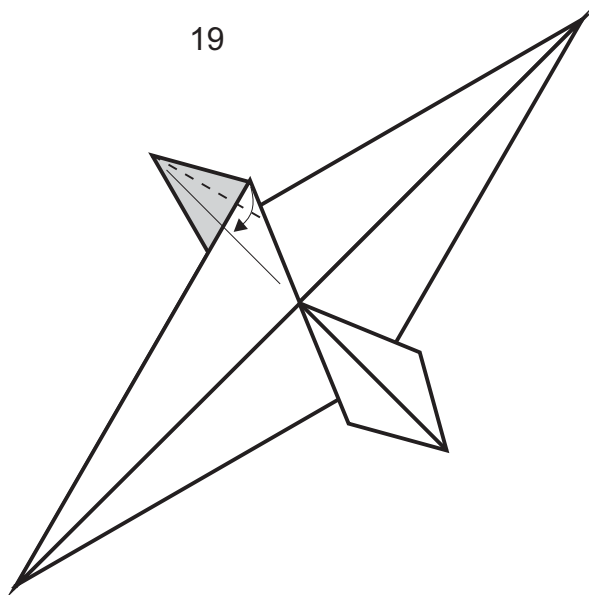

20 intascare

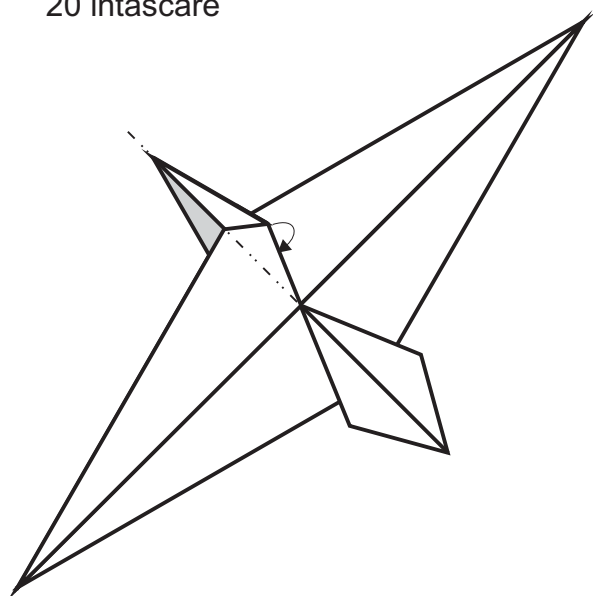

21

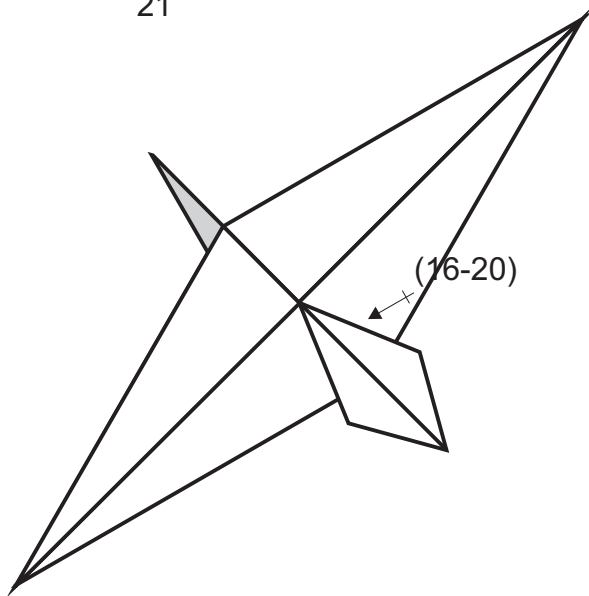

22

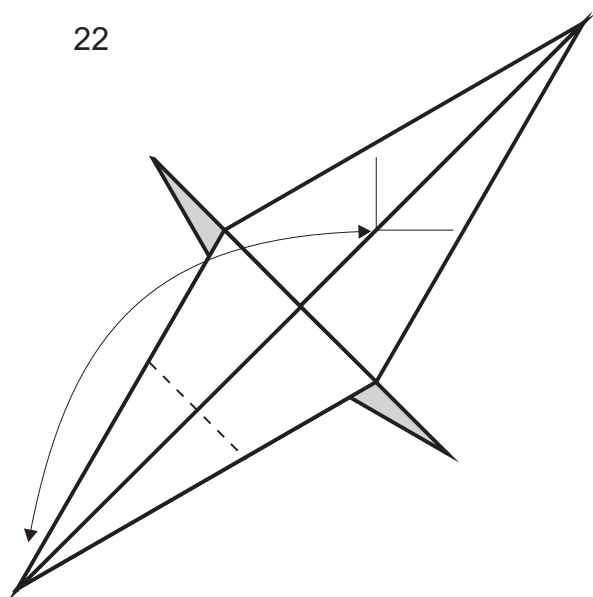

23

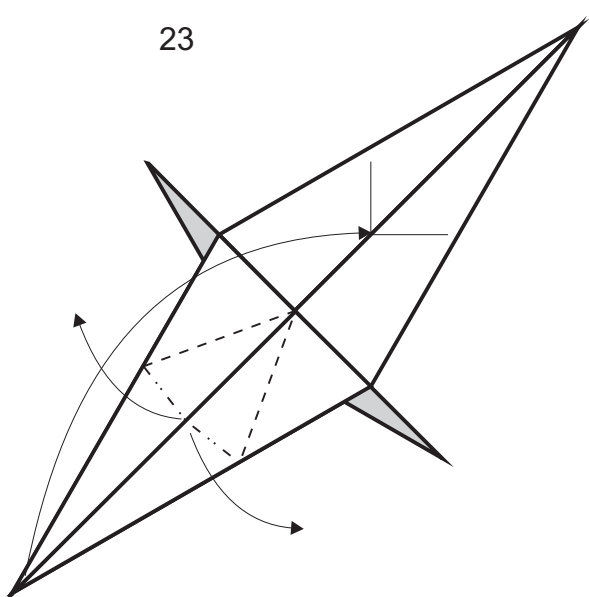

24

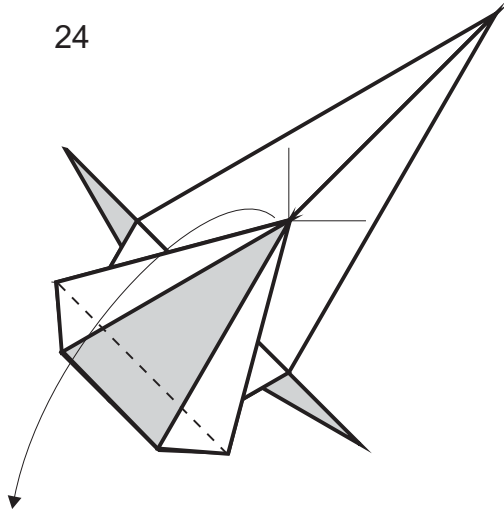

25

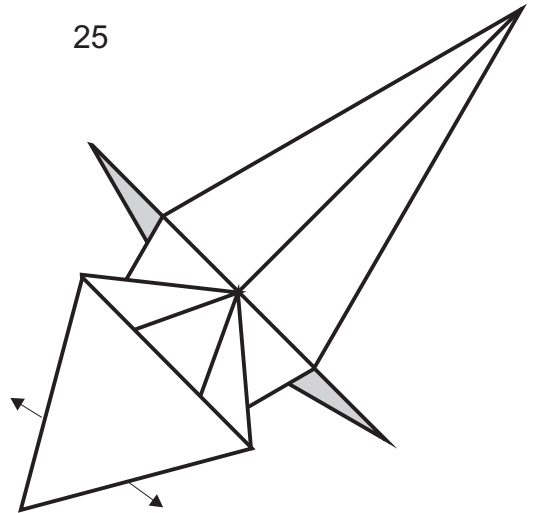

26

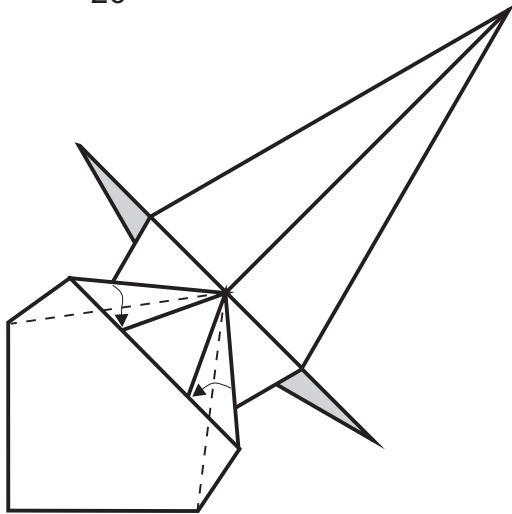

27

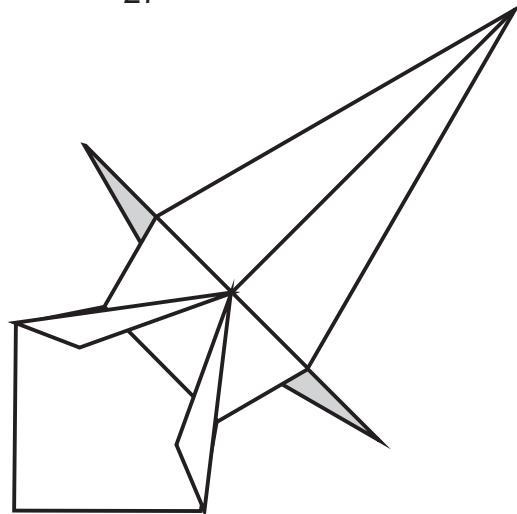

28

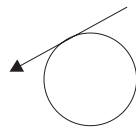
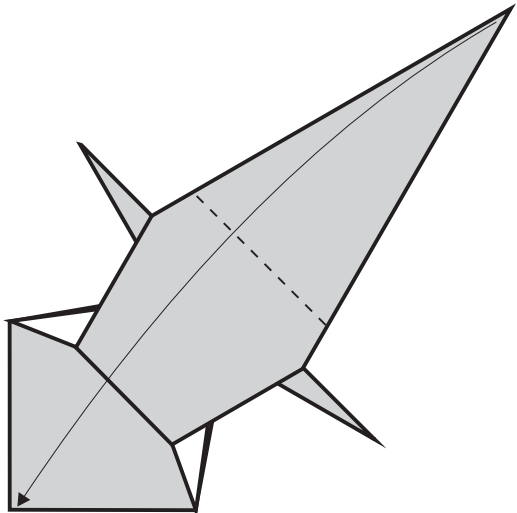

29

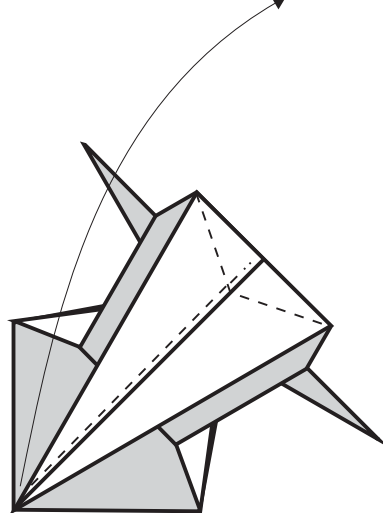

30

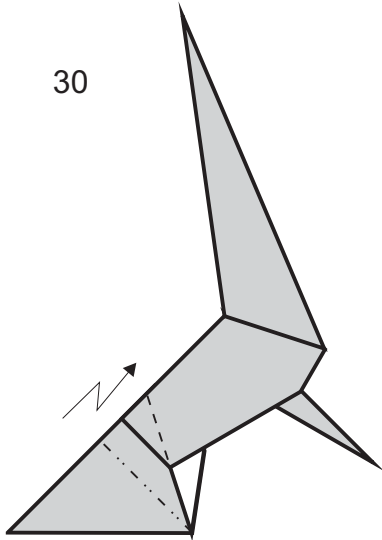

31

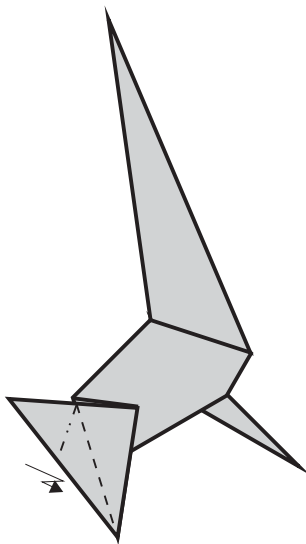

32

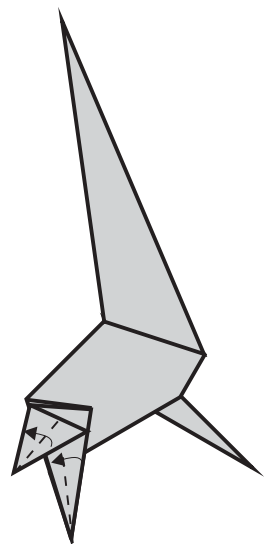

33 riaprire

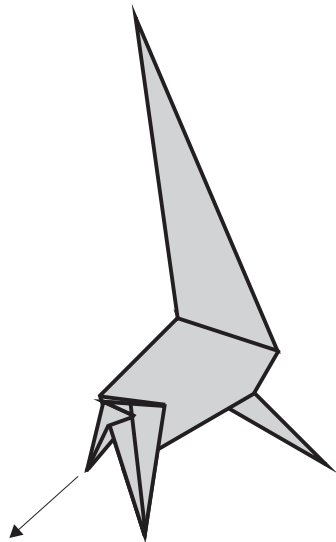

34

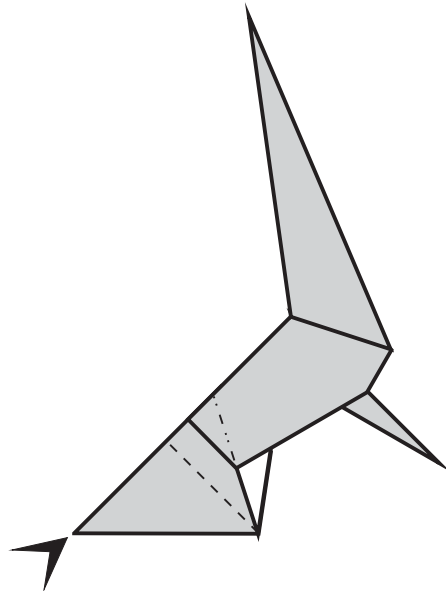

35

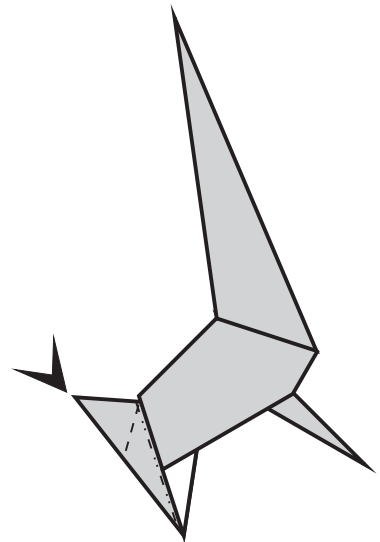

36 riaprire solo quanto basta per poter fare la piega

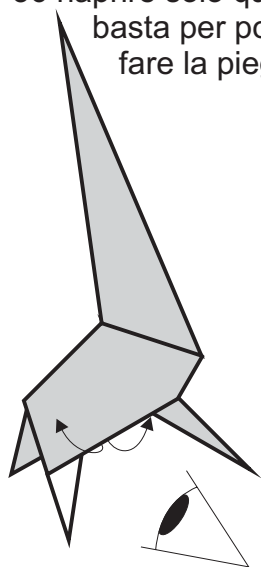

37

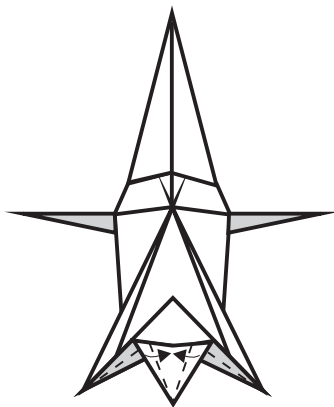

38

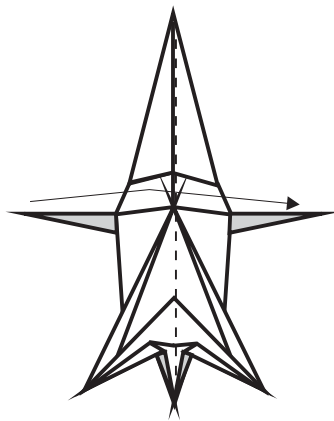

39

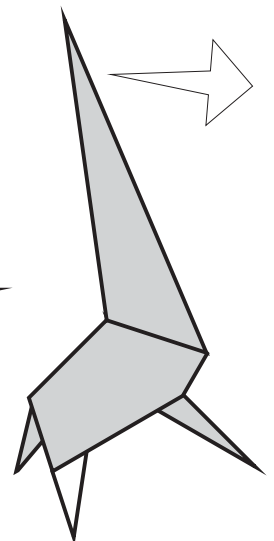

40

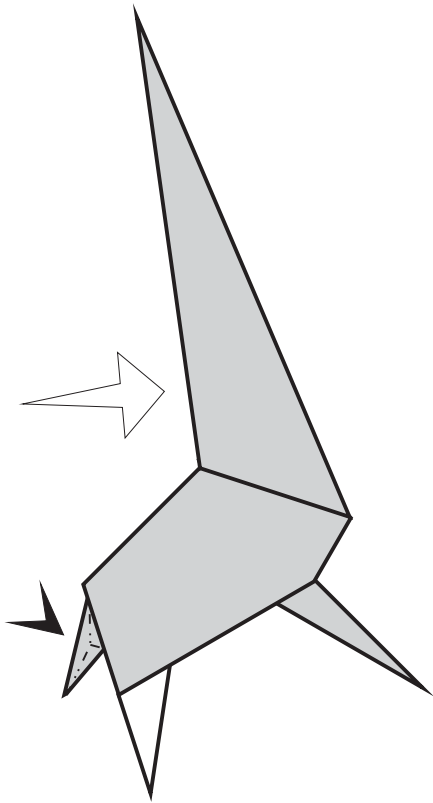

41

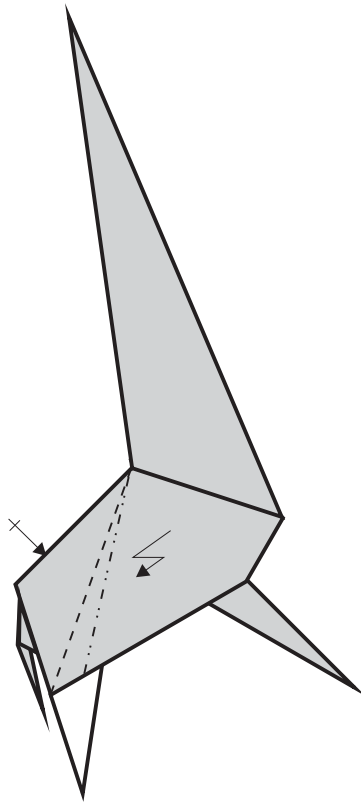

42

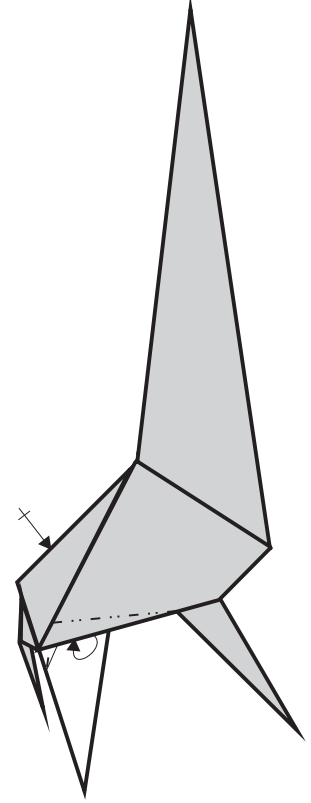

43

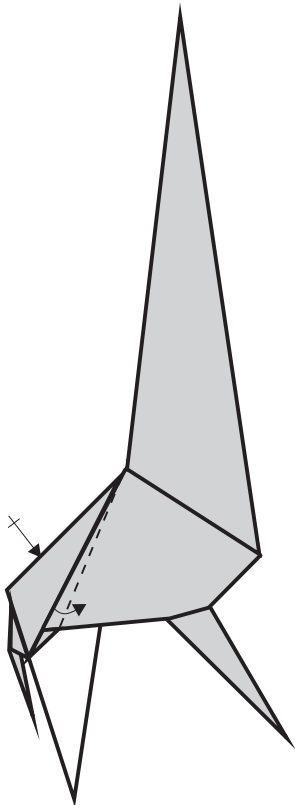

44

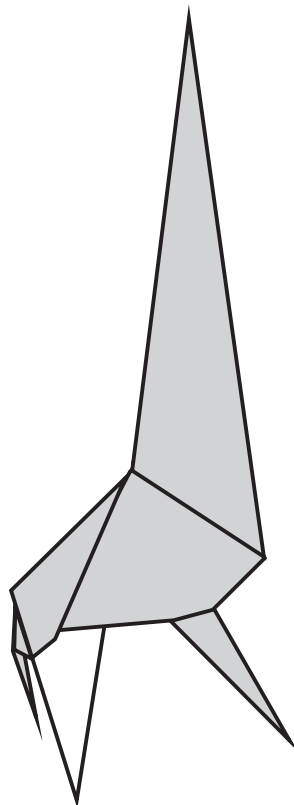

45 inserendo un dito,
la parte superiore
della piega deve
venire curva

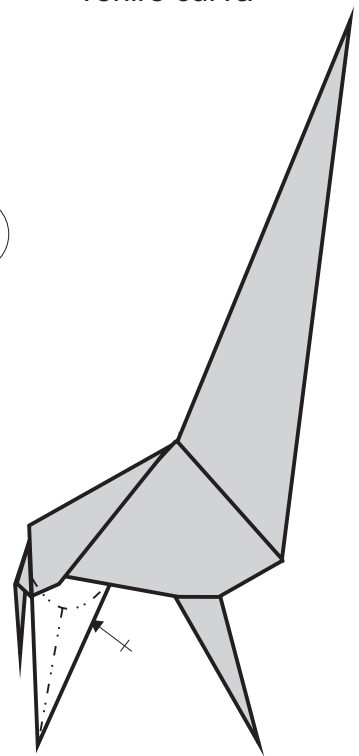

46 pizzicare la
zampa per
ottenere la
posizione del
passo 47

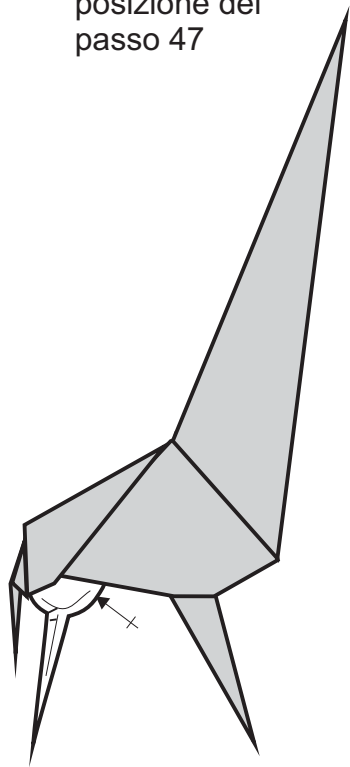

47 sink chiuso

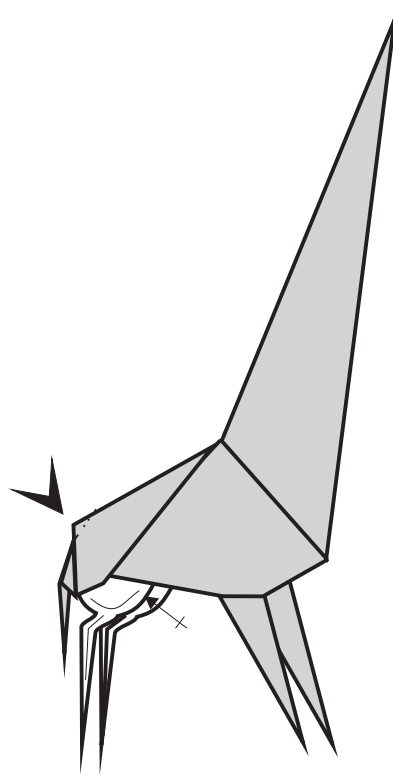

48

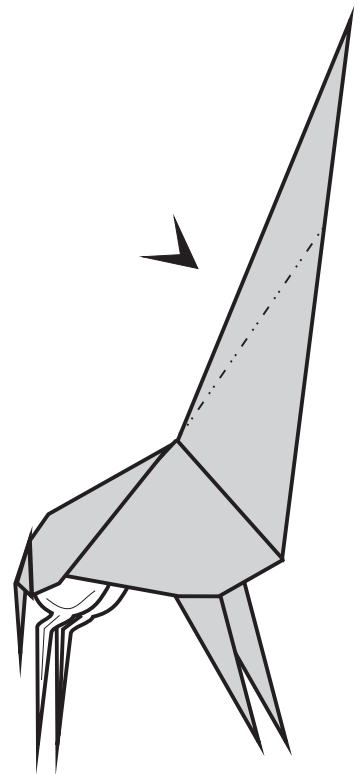

49

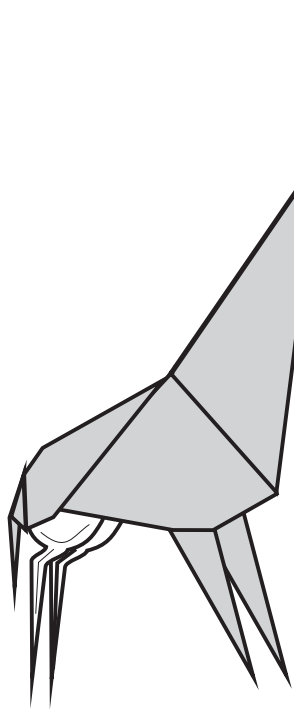

50

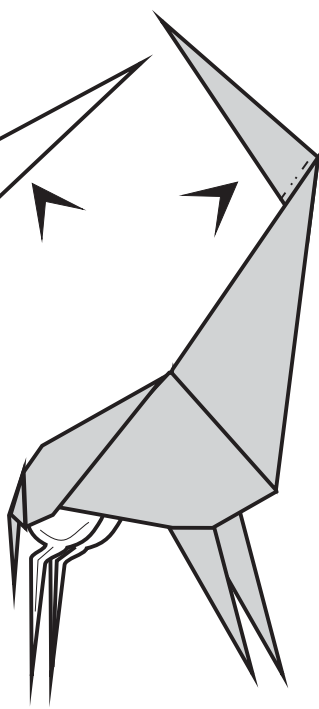

51

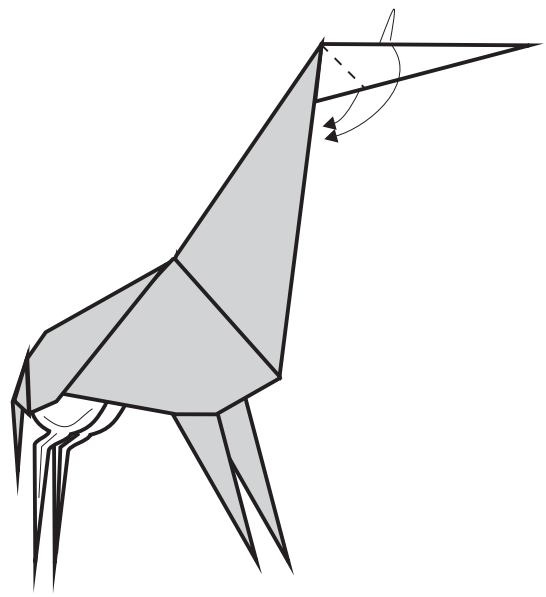

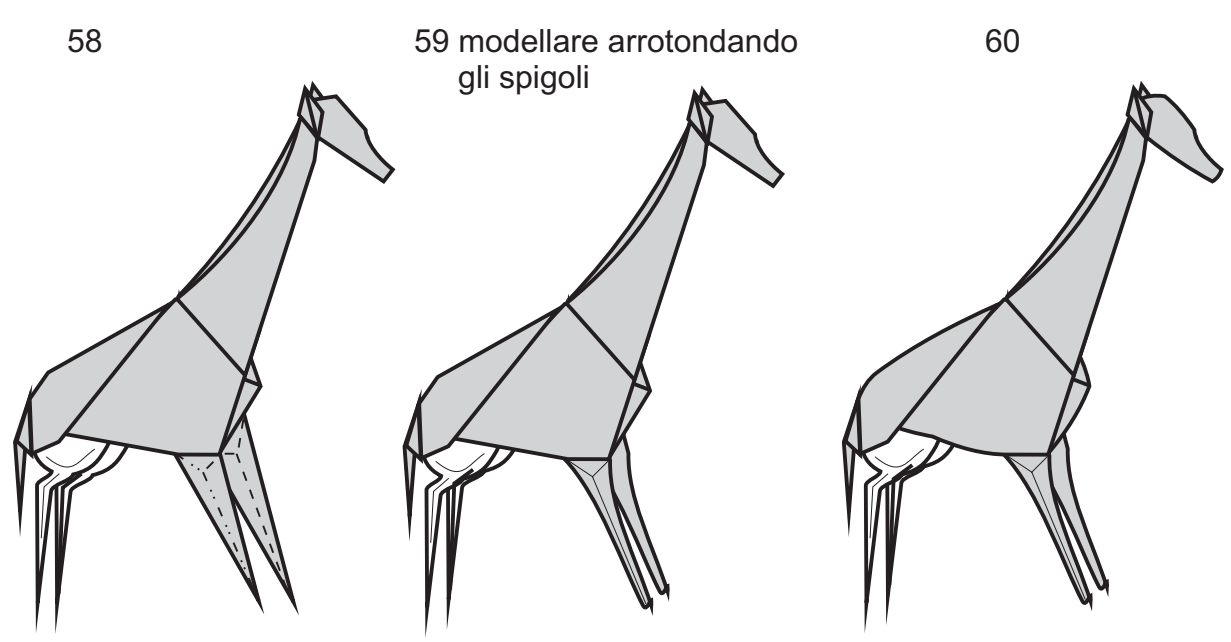
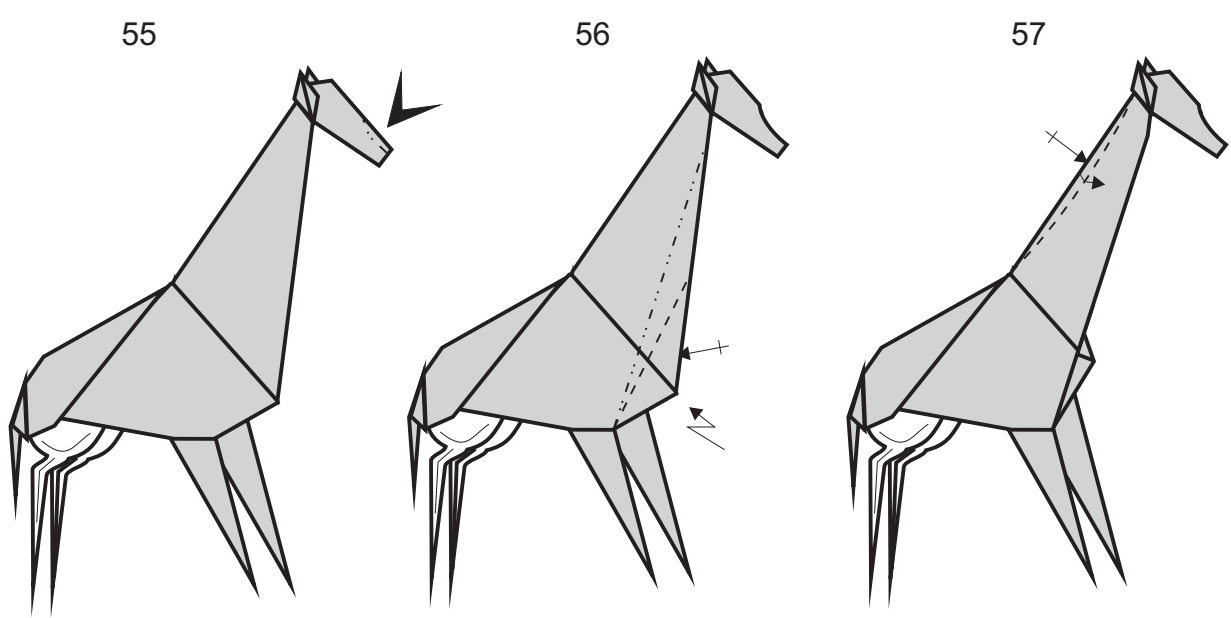
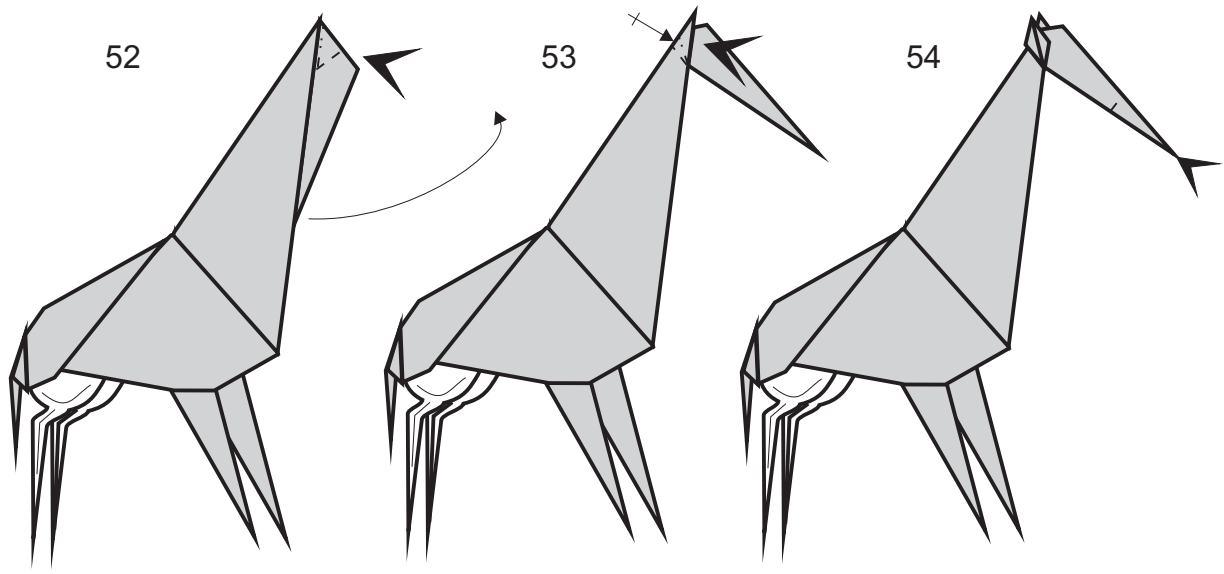

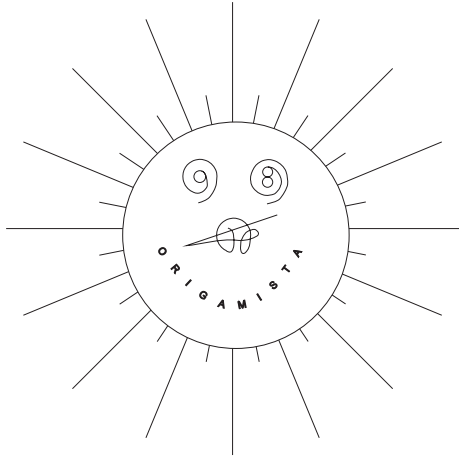

Il bello di essere una giraffa è che sei sempre all'altezza della situazione

