

Armonica che suona

di P. D'Auria

<http://www.origamidauria.it>

origami composto, per far sì che l'armonica suoni veramente la grandezza del modello è determinante, per questa ragione vi fornirò l'esatto formato dei fogli.

Cassa

Usare un rettangolo 38X10 cm di carta metallizzata

1 dividere in 19vesimi, segnando solo i punti

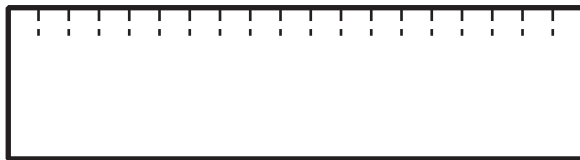

2

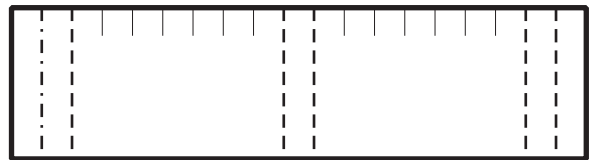

3

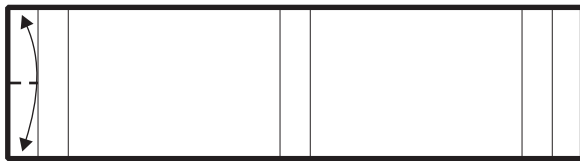

4

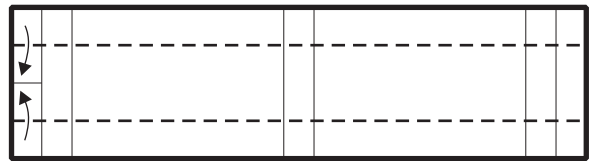

5 piegare a valle su 1/10 e su 9/10

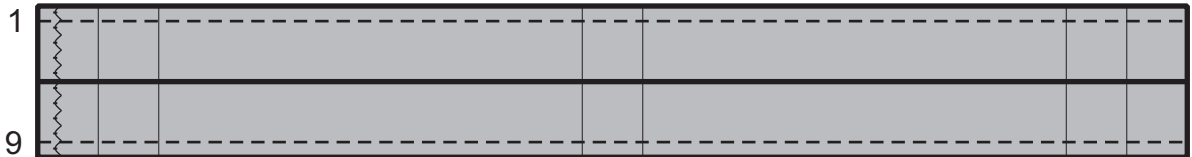

6 riaprire

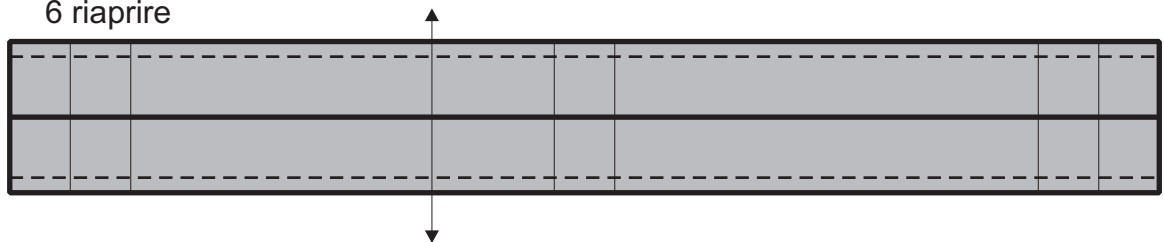

7

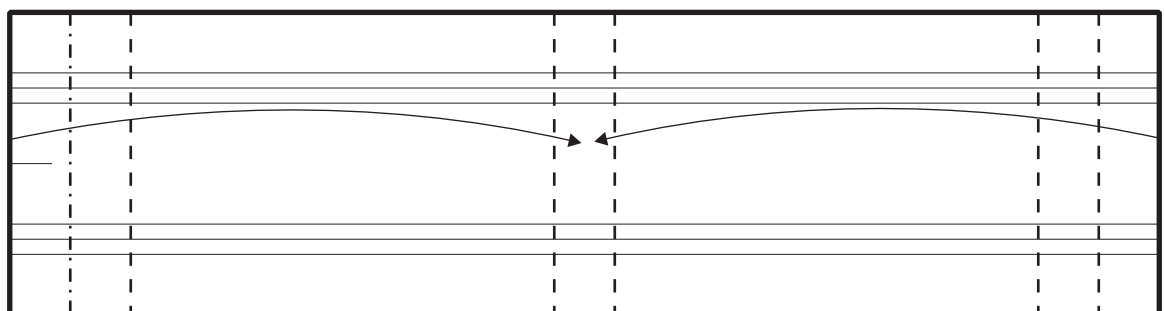

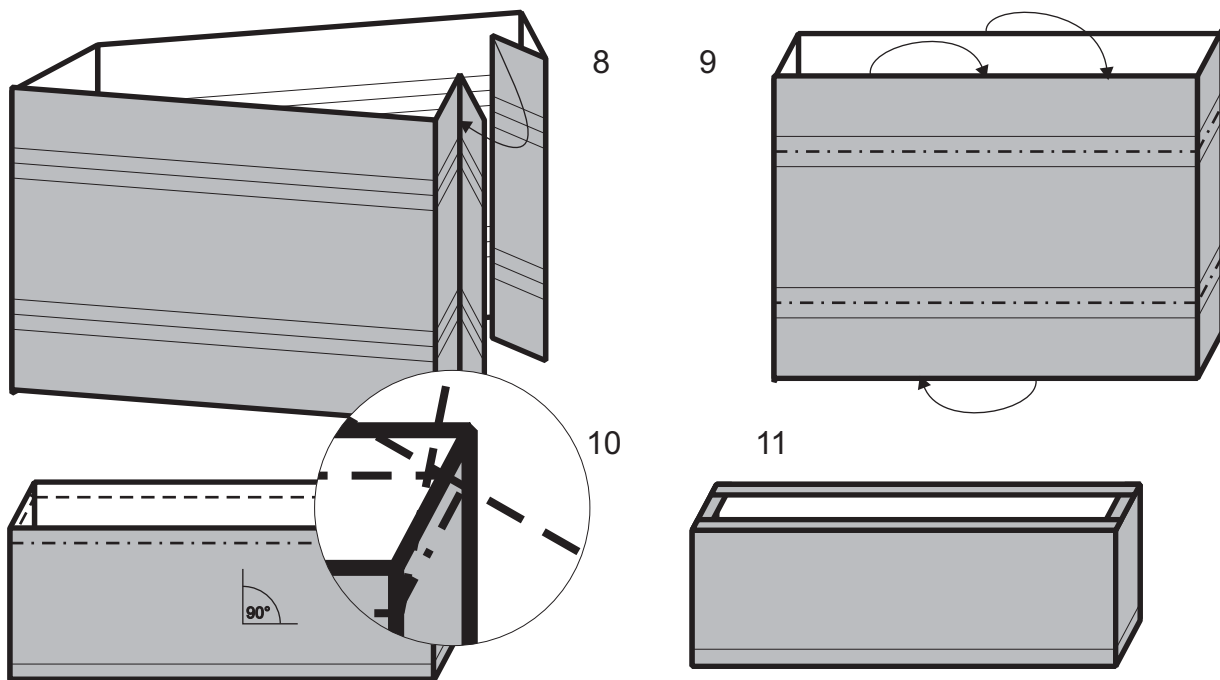

Divisori

Usare un rettangolo 6,4X3,9 cm di carta metallizzata

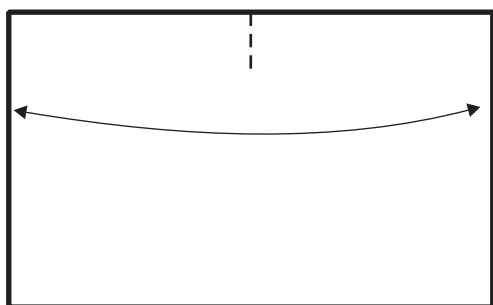

12

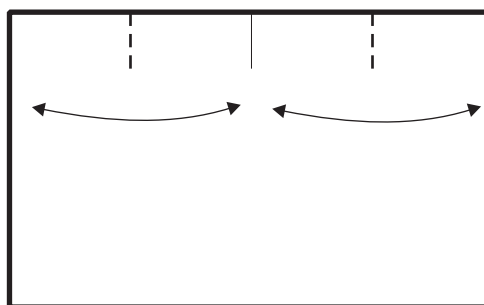

13

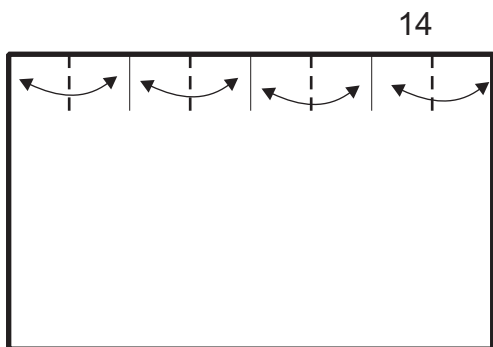

14

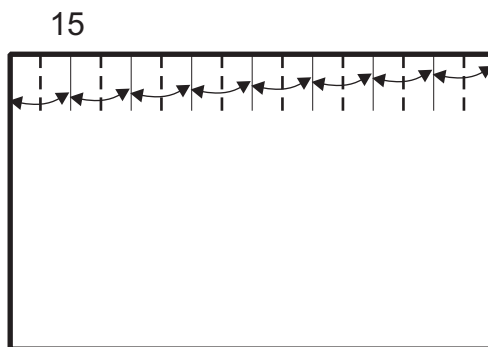

15

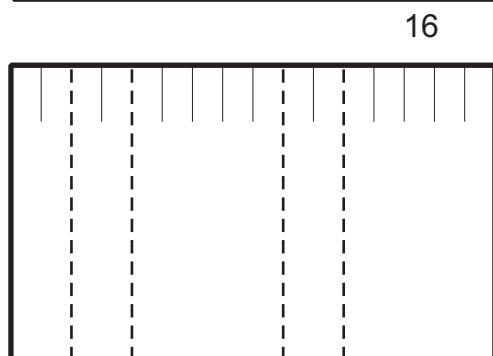

16

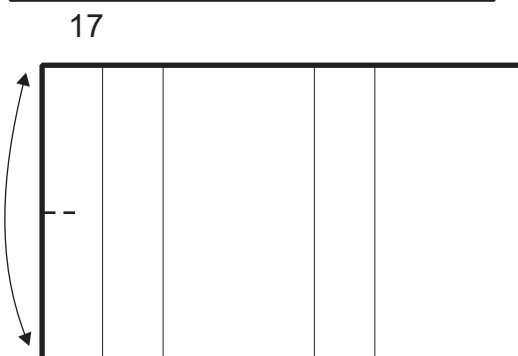

17

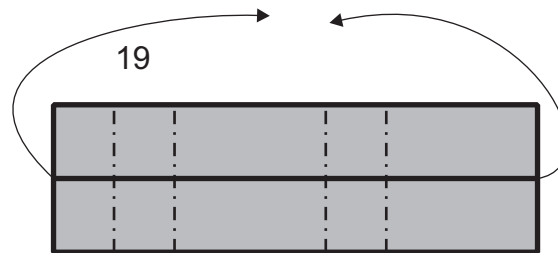
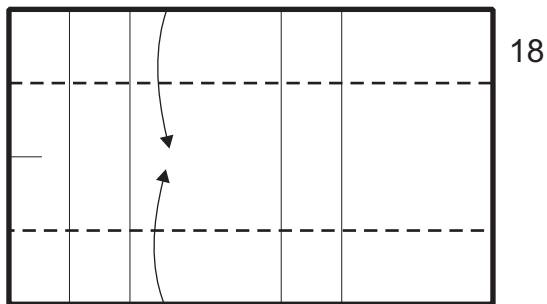

21 il numero divisori varia in rapporto allo spessore della carta, alla precisione delle pieghe e alla nostra capacità di incastrarli nella cassa, ma all'incirca ne occorrono 32.

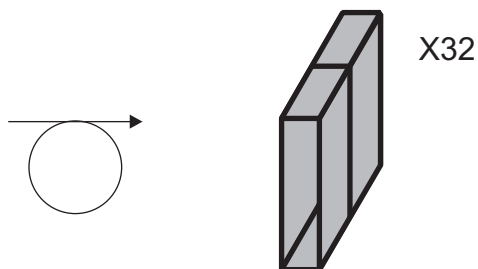
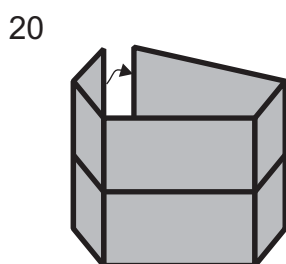

Lamella

Usare un rettangolo 13,8X1,8 cm di carta da fotocopie (80 g/m²), per produrre suoni diversi si può provare anche carta con un'altra grammatura



Cover

Usare un rettangolo 38X6 cm preferibilmente di carta elefante

21 dividere in 19vesimi, segnando solo i punti

22



23

24

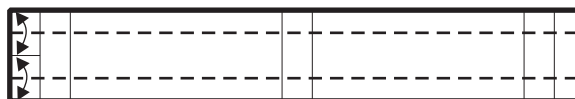

25

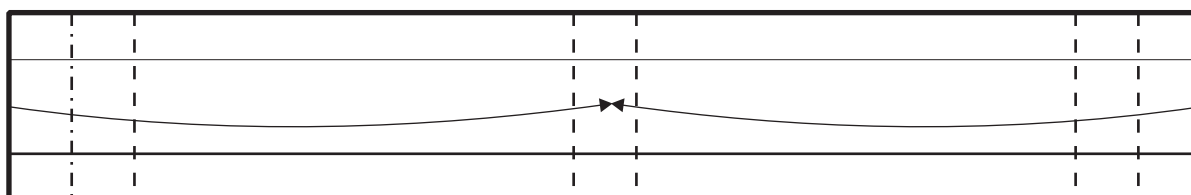

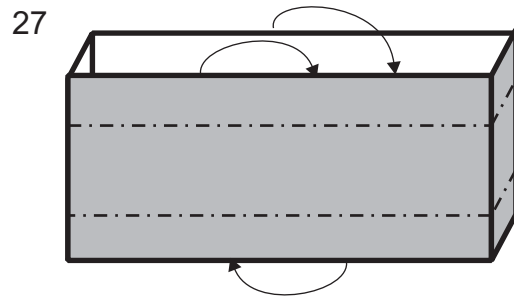
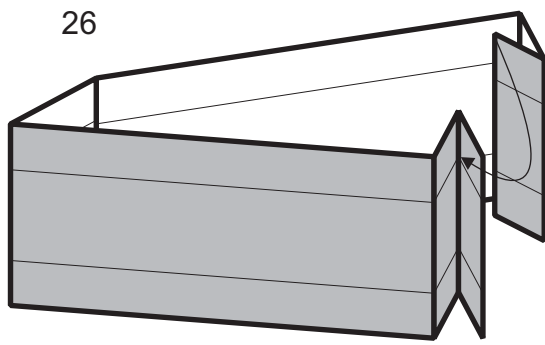

28 si può ottenere un cover più elaborato creando una tassellazione



Assemblaggio



30 inserire fino in fondo la metà dei divisori piegati (come già detto il numero è variabile)

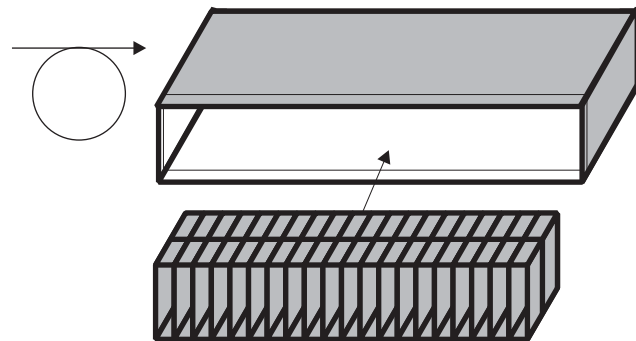

31 introdurre la lamella appoggiandola sui divisori

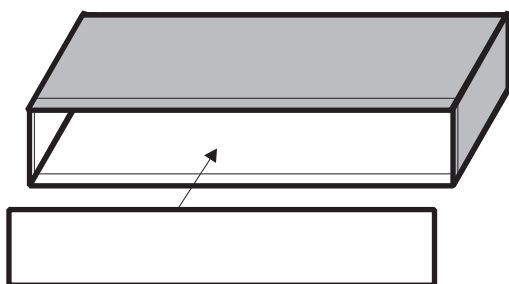

32 inserire la seconda metà dei divisori

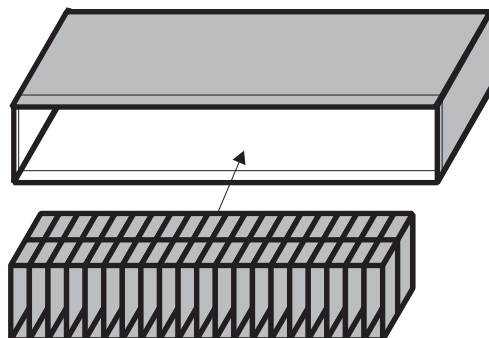

33 come il passaggio 10

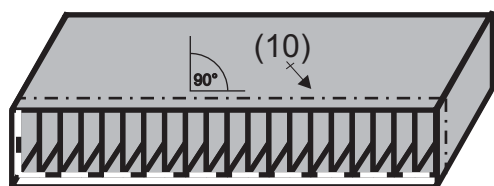

34 ci si può aiutare con un foglio di carta, usandolo come un calzascarpe

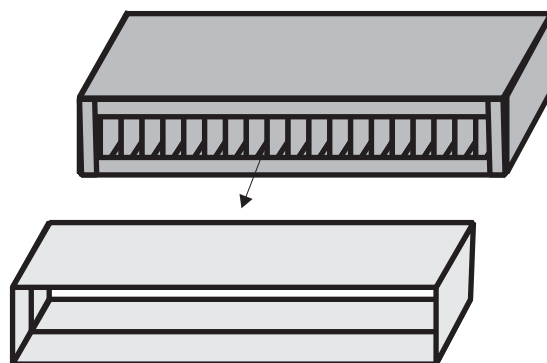

35

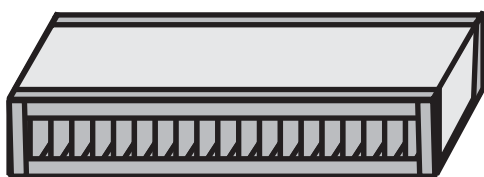

per far suonare l'armonica occorre modulare una vocale (preferibilmente una a o una o) e far entrare in vibrazione la cassa dell'armonica.

La musica va studiata da giovani...
perché da vecchi non si riesce più
a fare le scale!!!!



Per sentirmi suonare quest'armonica:

https://www.youtube.com/watch?v=nEOZ6d94lQU&feature=youtube_gdata